



[www.poliplastsrl.com](http://www.poliplastsrl.com)

LISTINO PRODOTTI FEBBRAIO **2025**

**24W 2400Lm**

Dim. Ø280x55

**ZELDA**  
**€ 41,800**

401039X



TECNOLOGIA  
TRICOLOR

IP 65 IMB 14/1

**24W 2400Lm**

Dim. 280x280x48

**ZELDA**  
**€ 44,551**

401040X



TECNOLOGIA  
TRICOLOR

IP 65 IMB 14/1

**14W 1400Lm**

Dim. 204X109X57

Cornice nera inclusa

**EMMA**  
**€ 21,724**

401041X



TECNOLOGIA  
TRICOLOR

IP 54 IMB 12/1

**14W 1400Lm**

Dim. Ø224x63

Cornice nera inclusa

**EMMA**  
**€ 28,600**

401042X



TECNOLOGIA  
TRICOLOR

IP 54 IMB 12/1

**EMMA**  
**€ 2,971**

401043BI ○  
401043NE ●

Cornici per  
art. 401041X



401043BI



401043NE

IMB  
40/10/1

**EMMA**  
**€ 2,971**

401044BI ○  
401044NE ●

Cornici per  
art. 401041X



401044BI



401044NE

IMB  
40/10/1

**EMMA**  
**€ 4,291**

401045BI ○  
401045NE ●

Cornici per  
art. 401042X



401045BI



401045NE

IMB  
40/10/1

**12W 1250Lm**

Dim. 280x280x39



**SHARON**  
€ 28,267

400910X



TECNOLOGIA TRICOLOR IP 20 IMB 8/1

**12W 1250Lm**

Dim. Ø268x85



**CINDY**  
€ 24,391

400829X



TECNOLOGIA TRICOLOR IP 20 IMB 8/1

**18W 2000Lm**

Dim. 330x330x39



**SHARON**  
€ 36,260

400911X

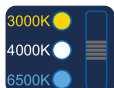

TECNOLOGIA TRICOLOR IP 20 IMB 8/1

**18W 2000Lm**

Dim. Ø306x95



**CINDY**  
€ 30,264

400830X



TECNOLOGIA TRICOLOR IP 20 IMB 8/1

**24W 2750Lm**

Dim. 380x380x39



**SHARON**  
€ 39,689

400912X



TECNOLOGIA TRICOLOR IP 20 IMB 8/1

**24W 2800Lm**

Dim. Ø390x115



**CINDY**  
€ 37,116

400831X



TECNOLOGIA TRICOLOR IP 20 IMB 8/1



**12W 1160Lm**

Dim. 128x128



**DAISY**  
€ 16,044

- 400832W
- 400832C
- 400832D

IP 20 IMB 20/10/1

**20W 2050Lm**

Dim. 178x178



**DAISY**  
€ 25,289

- 400833W
- 400833C
- 400833D

IP 20 IMB 20/10/1

**30W 3200Lm**

Dim. 238x238



**DAISY**  
€ 34,260

- 400834W
- 400834C
- 400834D

IP 20 IMB 20/10/1

**9W 900Lm**

Dim. 212x118x90



**MEGAN**  
€ 17,149

- 400811BI
- 400811NE

IP 65 IMB 20/1

**E27** NEW  
Dim. Ø185x105



**GINA1**  
**€ 10,267**  
002003BI ○  
002003NE ●

IP 54 IMB 20/1

**E27** NEW  
Dim. 175x120x100



**GINA2**  
**€ 9,383**  
020040BI ○  
020040NE ●

IP 54 IMB 20/1



**2xE27** NEW  
Dim. Ø300x95



**ANTONELLA**  
**€ 21,956**  
401122

IP 65 IMB 10/1



**GU10**

Dim. Ø100x25

**LUCIA**  
**€ 8,551**

 400720  
 35W max

**GU10**

Dim. 100x100x25

**NOVELLA**  
**€ 8,551**

 400721  
 35W max

**GU10**

Dim. 120x120x45

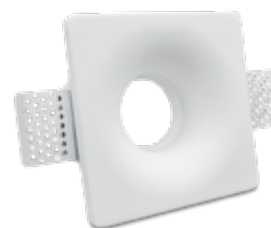
**LUNA**  
**€ 8,684**

 400954  
 35W max

**GU10**

Dim. 80x80x50

**PIPER**  
**€ 11,420**

 400990  
 35W max

**GU10**

Dim. 120x120x60

**GALATEA**  
**€ 15,107**

 400723  
 35W max

**GU10**

Dim. 150x150x60

**FOSCA**  
**€ 27,369**

 400726  
 35W max

**G53 AR111**

Dim. 180x180x65

**NIVES**  
**€ 65,507**

 400724  
 75W max

**2xGU10**

Dim. 215x118x58

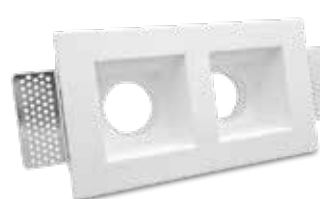
**EDDA**  
**€ 19,713**

 400966  
 2x35W max

**GU10**

Dim. Ø130x70

**TECLA**  
**€ 11,209**

 400722  
 35W max

**GU10**

Dim. Ø175x88

**FULVIA**  
**€ 34,938**

 400734  
 35W max

**GU10**

Dim. 120x120x55

**CORA**  
**€ 16,011**

 400732  
 35W max

<p><b>GU10</b> Dim. 360x300x75</p>  <p><b>ELSA</b> <b>€ 70,018</b></p> <p>400967 35W max</p> <p>IP 20 IMB 2/1 305x365</p>	<p><b>GU10</b> Dim. 345x130x85</p>  <p><b>EVA</b> <b>€ 33,311</b></p> <p>400968 35W max</p> <p>IP 20 IMB 6/1 350x135</p>	
<p><b>2xE14</b> Dim. 360x70x90 Luce bidirezionale</p>  <p><b>SARA</b> <b>€ 44,187</b></p> <p>400975 2x20W max</p> <p>IP 20 IMB 6/1</p>	<p><b>2xE14</b> Dim. 400x100x160 Luce bidirezionale</p>  <p><b>EMANUELA</b> <b>€ 109,176</b></p> <p>400733 2x42W max</p> <p>IP 20 IMB 4/1</p>	<p><b>2xE27</b> Dim. 250x250x90</p>  <p><b>MEDEA</b> <b>€ 116,456</b></p> <p>400735 2x75W max</p> <p>IP 20 IMB 3/1 255x255</p>



<p><b>GU10</b> Dim. Ø70x90</p>  <p><b>FLORA</b> <b>€ 19,033</b></p> <p>400969 9W max</p> <p>IP 20 IMB 20/1</p>	<p><b>GU10</b> Dim. Ø70x110</p>  <p><b>GAIA</b> <b>€ 21,073</b></p> <p>400970 9W max</p> <p>IP 20 IMB 12/1</p>	<p><b>GU10</b> Dim. Ø70x130</p>  <p><b>LICIA</b> <b>€ 23,113</b></p> <p>400971 9W max</p> <p>IP 20 IMB 12/1</p>
<p><b>GU10</b> Dim. 70x70x90</p>  <p><b>MARA</b> <b>€ 19,713</b></p> <p>400972 9W max</p> <p>IP 20 IMB 18/1</p>	<p><b>GU10</b> Dim. 70x70x110</p>  <p><b>NICLA</b> <b>€ 21,753</b></p> <p>400973 9W max</p> <p>IP 20 IMB 12/1</p>	<p><b>GU10</b> Dim. 70x70x130</p>  <p><b>ROSA</b> <b>€ 23,793</b></p> <p>400974 9W max</p> <p>IP 20 IMB 12/1</p>

### GU10

Dim. Ø80x26

- 400571BI ○
- 400571NE ●



**ELIDE**  
€ 4,262



### GU10

Dim. Ø80x26

- 400571AL ○
- 400571CR ○
- 400571OR ○
- 400571ST ○
- 400571RA ●



**ELIDE**  
€ 4,760



### GU10

Dim. Ø84x26

- 400572BI ○
- 400572NE ●



**DANIRA**  
€ 5,340



### GU10

Dim. Ø84x26

- 400572AL ○
- 400572CR ○
- 400572OR ○
- 400572ST ○
- 400572RA ●



**DANIRA**  
€ 6,011



REGOLABILE

REGOLABILE

### GU10

Dim. 84x84x28

- 400619BI ○
- 400619NE ●



**NOEMI**  
€ 5,924



### GU10

Dim. 84x84x28

- 400619AL ○
- 400619CR ○
- 400619OR ○
- 400619ST ○
- 400619RA ●



**NOEMI**  
€ 6,669



REGOLABILE

REGOLABILE

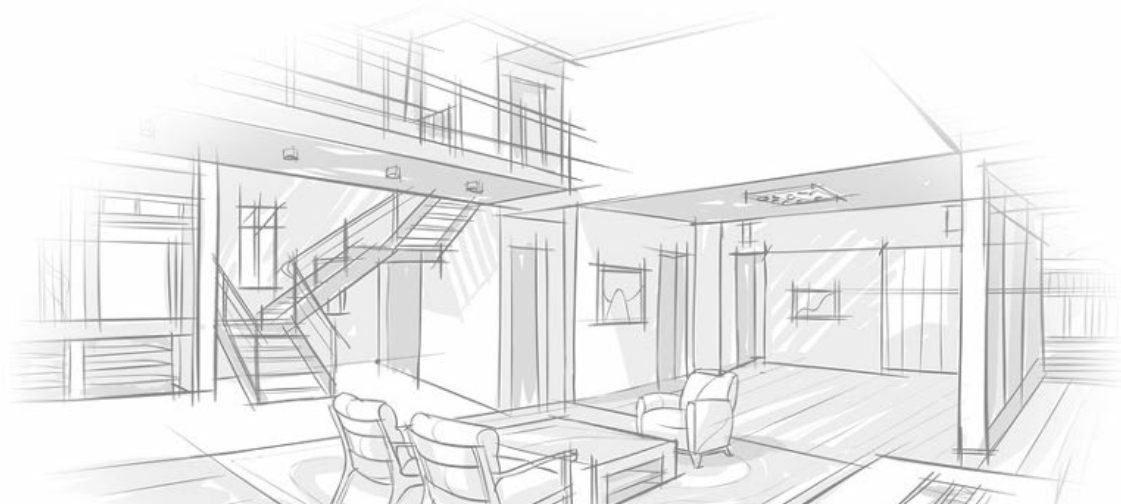



**GU10**

Dim. 86x86x48



**PAOLA**

**€ 8,593**

401010BI  
35W max



**GU10**

Dim. 86x86x48



**PAOLA**

**€ 8,593**

401010NE  
35W max



**GU10**

Dim. ø81x70



**RAFFAELLA**

**€ 7,096**

401011BI  
35W max



**GU10**

Dim. ø81x70



**RAFFAELLA**

**€ 7,096**

401011NE  
35W max



**GU10**

Dim. ø81x70



**RAFFAELLA**

**€ 7,096**

401011OR  
35W max



**GU10**

Dim. ø85x32

**NEW**



401090BI



401090NE

**ARIEL**

**€ 6,006**

35W max



**GU10**

Dim. 86x86x32

**NEW**



401091BI



401091NE

**KATRINE**

**€ 6,468**

35W max



**GU10**

Dim. ø85x32

**NEW**



401092BI



401092NE

**PENELOPE**

**€ 6,996**

35W max



**GU10**

Dim. 86x86x32

**NEW**



401093BI



401093NE

**GIOIA**

**€ 7,458**

35W max



**6.7W 700Lm**

Dim. Ø87x47



TECNOLOGIA  
TRICOLOR

**NAOMI**  
€ 16,184

400958X



IP 65 IMB 48/1

**10W 1100Lm**

Dim. Ø105x58,5mm



TECNOLOGIA  
TRICOLOR

**ELISA**  
€ 19,978

401025X



IP 65 IMB 36/1

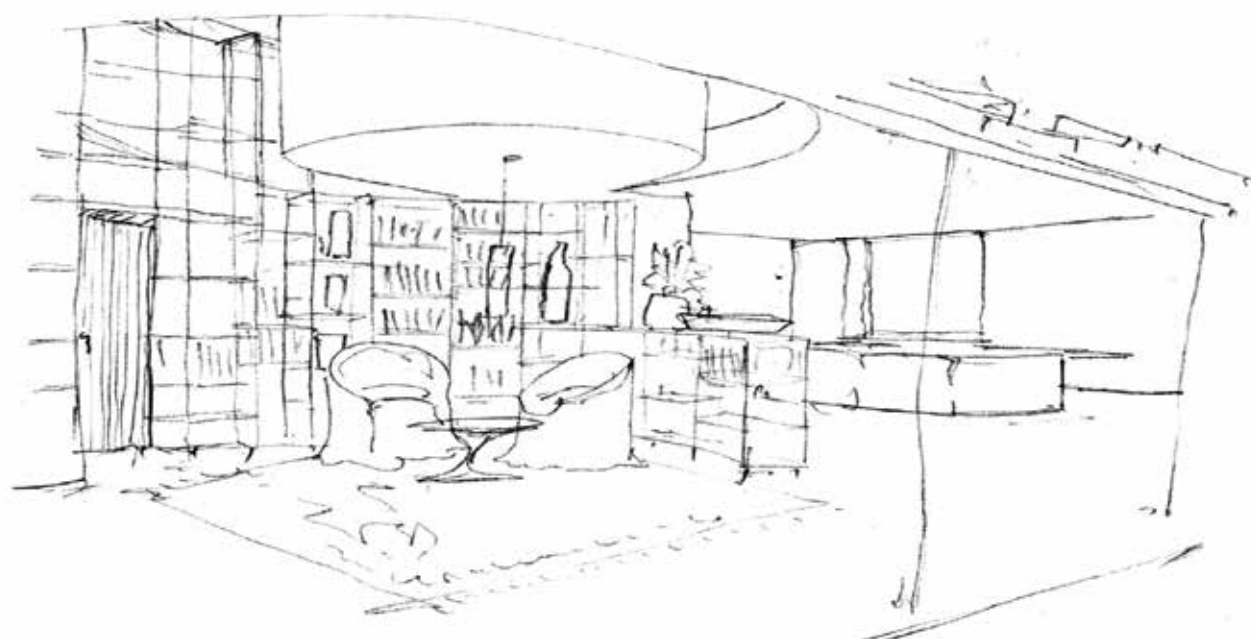

**E27**

Dim. Ø100x200  
Cavo 1000mm



IMB 6/1 IP 20

**VIOLA**  
€ 35,956

400976

**E27**

Dim. Ø210x230  
Cavo 1000mm



IMB 6/1 IP 20

**VIRGINIA**  
€ 45,667

400977

**GU10**

Dim. Ø60x400  
Cavo 1200mm



IMB 10/1 IP 20

**ELODY**  
€ 31,444

400961BI ○  
400961NE ●

**40W 5000Lm**

Dim. 595x595



UGR<19

IP 20 IMB 5

GIORDANA  
IMB 5 € 38,800

- 400765C
- 400765D

**40W 4000Lm**

Dim. 595x595



UGR<19

TECNOLOGIA TRICOLOR IP 20 IMB 5

GIORDANA  
IMB 5 € 50,358

401046X



**40W 5000Lm**

Dim. 295x1195



UGR<19

IP 20 IMB 5

GIORDANA  
IMB 5 € 58,773

- 400767C
- 400767D

**40W 4000Lm**

Dim. 295x1195



UGR<19

TECNOLOGIA TRICOLOR IP 20 IMB 5

GIORDANA  
IMB 5 € 64,900

401047X



**24W 3000Lm**

Dim. 295x595



IP 20 IMB 5

GIORDANA  
IMB 5 € 77,949

- 400766C
- 400766D

**Kit sospensione**

per artt. 400765-766-767-401046X-47X



IMB 150/1

GIORDANA  
€ 9,020

400768

**Kit cornice**

in alluminio per artt. 400765-766-767-401046X-47X

GIORDANA  
40076906060  
€ 25,604

GIORDANA  
40076903060  
€ 26,807

GIORDANA  
40076930120  
€ 31,780

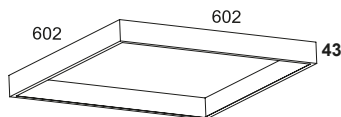

40076906060 IMB 10/1

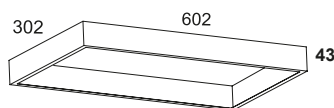

40076903060 IMB 10/1

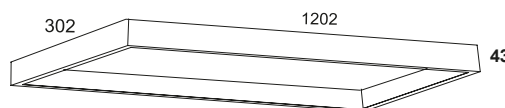

40076930120 IMB 10/1

**6W KIT EMERGENZA**

Dim. 170x55x28



400793 100/150/200mA | 6W

Input 220-240V~  
Tens. max 55V

IP 20 IMB 20/1

**Driver**

per artt. 400765 - 400767 - 400942



401038

€ 21,000

IMB 1

**20W 1800Lm**

**FIONA**  
**€ 78,962**

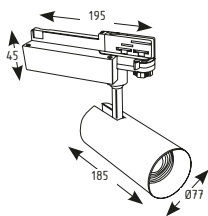
 400987CBI    
 400987CNE  

**IP 20** **IMB 20/1**
**30W 2700Lm**

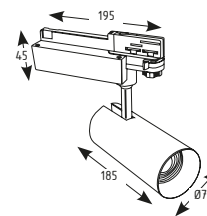
**FIONA**  
**€ 88,536**

 400988CBI    
 400988CNE  

**IP 20** **IMB 20/1**
**Accessori 220-240V~**

**€ 72,871**
**400814BI**  
 Binario elettr., allum., lungh. 2 mt, trifase

**€ 11,093**
**400812B-SX**  
 Alimentazione SX per art. 400814

**€ 18,227**
**400815BI**  
 Giunto a L.90°

**€ 11,093**
**400812B-DX**  
 Alimentazione DX per art. 400814

**€ 1,600**
**400813BI**  
 TAPPO DI CHIUSURA

**IOLANDA**

- 400812B-DX **IMB 100/1**
- 400812B-SX **IMB 100/1**
- 400813BI **IMB 200/1**
- 400814BI **IMB 10/1**
- 400815BI **IMB 100/1**
- 400816BI **IMB 100/1**
- 400817B-DX **IMB 50/1**
- 400818BI **IMB 40/1**
- 400880 **IMB 100/1**

**400816BI**  
 Giunto lineare  
**€ 18,227**

**€ 28,064**
**400817B-DX**  
 Giunto a T destro

**€ 37,238**
**400818BI**  
 Giunto a X

**€ 18,489**
**400880**  
 Kit sospensione (1,5 mt) per art. 400814

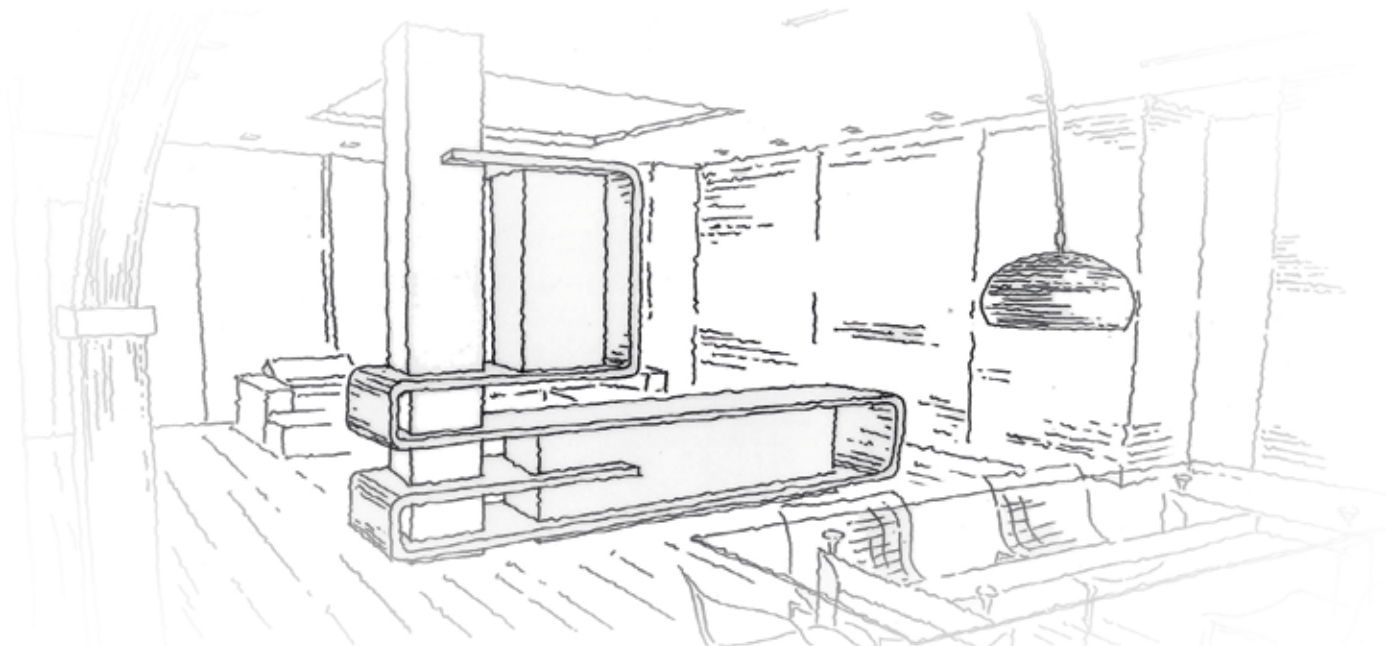
**IP 20**

**KIT PROFILI 400929**

Kit composto da:

- 1xProfilo
- 1xDiffusore
- 2xTappi
- 2xClips

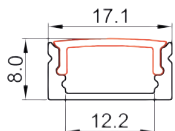

**€ 10,667**

IP 20 2 mt IMB 40/10

**KIT PROFILI 401071**

**€ 13,332**

Kit composto da:

- 1xProfilo
- 1xDiffusore PMMA
- 2xTappi
- 2x Clips

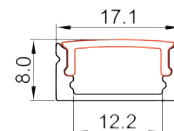

IP 20 2 mt IMB 40/10

**KIT PROFILI 400930**

Kit composto da:

- 1xProfilo
- 1xDiffusore
- 2xTappi

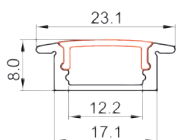

**€ 11,778**

IP 20 2 mt IMB 40/10

**KIT PROFILI 401072**

**€ 13,332**

Kit composto da:

- 1xProfilo
- 1xDiffusore PMMA
- 2xTappi
- 2x Clips

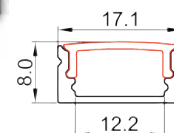

IP 20 2 mt IMB 40/10

**KIT PROFILI 400931**

**€ 14,652**

Kit composto da:

- 1xProfilo
- 1xDiffusore
- 2xTappi
- 2xClips

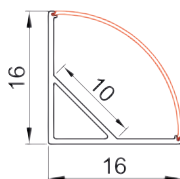

IP 20 2 mt IMB 32/8

**KIT PROFILI 401073**

**€ 14,652**

Kit composto da:

- 1xProfilo
- 1xDiffusore PMMA
- 2xTappi
- 2x Clips

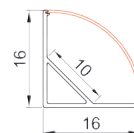

IP 20 2 mt IMB 32/8

**KIT PROFILI 400932**

**€ 18,020**

Kit composto da:

- 1xProfilo
- 1xDiffusore
- 2xTappi
- 2xClips

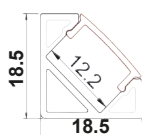

IP 20 2 mt IMB 24/6

**KIT PROFILI 400949**

**€ 20,262**

Kit composto da:

- 1xProfilo
- 1xDiffusore
- 3xTappi
- 4xClips



Profilo in alluminio flessibile

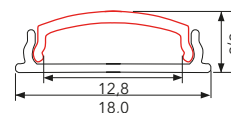

IP 20 2 mt IMB 60/15

**KIT PROFILI 400933**

**€ 37,209**

Kit composto da:

- 1xProfilo
- 1xDiffusore
- 2xTappi



Profilo da pavimento clapestabile

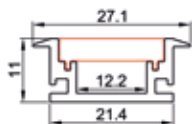

IP 20 2 mt IMB 24/6

**PIATTINA 400897**

**€ 9,318**

Piattina in alluminio estruso anodizzato

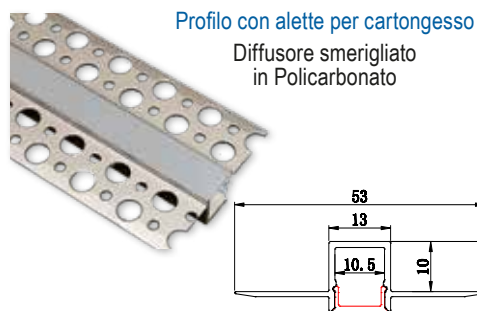

IP 20 2 mt IMB 100/10

**KIT PROFILI 400986**

**€ 25,147**

 Kit composto da:  
**1xProfilo**  
**1xDiffusore**  
**2xTappi**

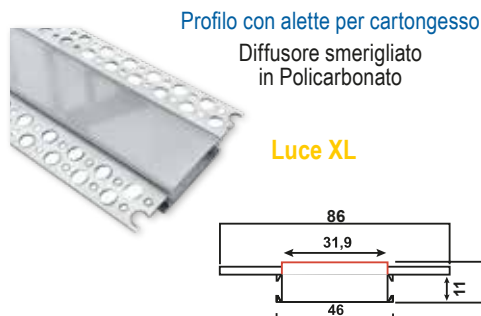
IP 20 2 mt IMB 12/3

**KIT PROFILI 401000**

**€ 66,000**

 Kit composto da:  
**1xProfilo**  
**1xDiffusore**  
**2xTappi**

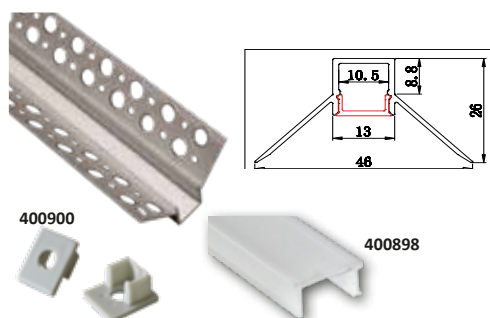
IP 20 2 mt IMB 10/5

**PROFILI 400895**

**€ 28,153**

 1xProfilo 400895  
 1xDiffusore 400898  
 2xTappi 400900

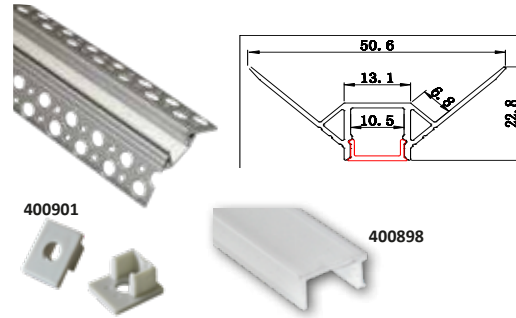
IP 20 2 mt IMB 3

**PROFILI 400896**

**€ 33,131**

 1xProfilo 400896  
 1xDiffusore 400898  
 2xTappi 400901

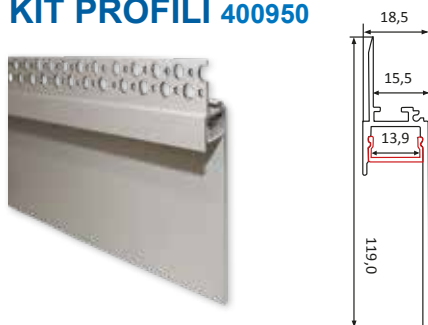
IP 20 2 mt IMB 3

**KIT PROFILI 400950**

**€ 76,300**

 Kit composto da:  
**1xProfilo**  
**1xDiffusore**  
**2xTappi**

IP 20 2 mt IMB 1

**COVER 401002SM**

**€ 28,512**

 Cover smerigliata  
**bobina 10mt**  
 per 400986

IP 20 10 mt IMB 10/1

**COVER 401003SM**

**€ 28,512**

 Cover smerigliata  
**bobina 10mt**  
 per 400929,  
 400930 - 400932

IP 20 10 mt IMB 10/1

**COVER 401077SM**

**€ 28,512**

 Cover nera  
**bobina 10mt**  
 per 401072

IP 20 10 mt IMB 10/1

**COVER 401001SM**

**€ 105,600**

 Cover smerigliata  
**bobina 10mt**  
 per 401000

IP 20 10 mt IMB 10/1

**KIT PROFILI 400943**

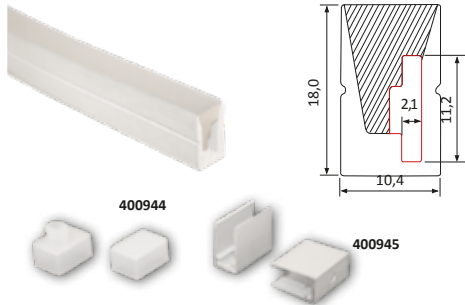

**€ 50,344**

- 1xProfilo silicone
- 1xDiffusore 400943
- 2xTappi 400944
- 6xClips 400945

IP 20 2 mt IMB 1

**KIT PROFILI 400946**

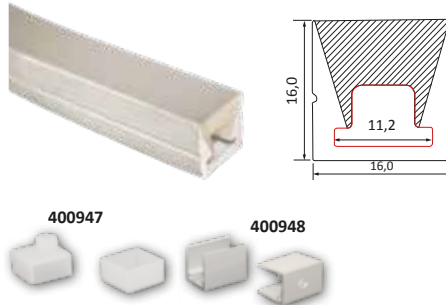

**€ 61,600**

- 1xProfilo silicone
- 1xDiffusore 400946
- 2xTappi 400947
- 6xClips 400948

IP 20 2 mt IMB 1

**PROFILO 401065**



**€ 37,400**

Profilo in alluminio corrodato da supporto in gesso e diffusore smerigliato.

1xProfilo lungh. 2 mt

IP 20 2 mt IMB 5/1

**PROFILO 401066**



**€ 20,350**

Connettore ad L con profilo in alluminio corrodato da supporto in gesso e diffusore smerigliato.

1 connettore misura 240x240mm

IP 20 IMB 20/4/1

**PROFILO 401067**

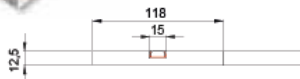

**€ 27,500**

Profilo in alluminio corrodato da supporto in gesso e diffusore smerigliato.

1xProfilo lungh. 2 mt

IP 20 IMB 20/4/1

**PROFILO 401068**

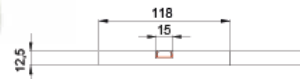

**€ 21,450**

Connettore a T con profilo in alluminio corrodato da supporto in gesso e diffusore smerigliato.

1 connettore misura 240x240mm

IP 20 IMB 20/4/1



**19,2 W/mt - IP20** Led 240/mt  
Dim. 10mmx5mt

**€ 50,882**

400979W   
400979C   
400979D 





Input 24Vcc Lm 2700  
Cons. 19,2W/mt Led SMD2835 240/mt

CRI >80 IP 20 IMB 50/1

**14,4 W/mt - IP20** Led 192/mt  
Dim. 10mmx5mt

**€ 43,318**

400965W   
400965C   
400965D 





Input 24Vcc Lm 2000  
Cons. 14,4W/mt Led SMD2835 192/mt

CRI >80 IP 20 IMB 50/1

**28.8 W/mt - IP20** Led 238/mt  
Dim. 10mmx5mt

**€ 55,556**

400925W   
400925C   
400925D 



Input 24Vcc Lm 3400  
Cons. 28.8W/mt Led SMD2835 238/mt

CRI >80 IP 20 IMB 50/1



**14,4 W/mt - IP65** Led 192/mt  
Dim. 10mmx5mt

**€ 49,500**

401069W   
401069C   
401069D 





Input 24Vcc Lm 2000  
Cons. 14,4W/mt Led SMD2835 192/mt

CRI >80 IP 65 IMB 50/1

**14,4 W/mt - IP67** Led 128/mt  
Dim. 10mmx5mt

**€ 72,058**

400980W   
400980C   
400980D 



Input 24Vcc Lm 1950  
Cons. 14,4W/mt Led SMD2835 128/mt

CRI >80 IP 67 IMB 25/1

**19,2 W/mt - IP67** Led 192/mt  
Dim. 10mmx5mt

**€ 82,344**

401012W   
401012C   
401012D 



Input 24Vcc Lm 2400  
Cons. 19,2W/mt Led SMD2835 192/mt

CRI >80 IP 67 IMB 25/1





**RGB - 14,4 W/mt - IP20** Led 60/mt  
Dim. 10mmx5mt

**€ 51,111**

400864 **RGB**



Input 24Vcc Lm RGB  
Cons. 14,4W/mt Led SMD5050 60/mt

CRI >80 IP 20 IMB 25/1

**RGB - 14,4 W/mt - IP55** Led 60/mt  
Dim. 10mmx5mt

**€ 71,111**

400884 **RGB**



Input 24Vcc Lm RGB  
Cons. 14,4W/mt Led SMD5050 60/mt

CRI >80 IP 55 IMB 25/1

**RGB CONTROLLER**  
Dim. 8,3x6,4x2,3

**€ 57,471**



IP 20 IMB 20/1

Input 100-240V~

**400865 - 18A | 12/24 Vcc | 3 canali**

**AMPLIFICATORE RGB**  
Dim. 10,5x6,4x2,3

**€ 33,076**



IP 20 IMB 20/1

Input 100-240V~

**400866 - 12A | 12/24 Vcc | 3 canali**



220-240V~

**12 W/mt - IP65** Led 120/mt  
Dim. 10mmx25mt

**€ 219,156**



401049W   
401049C   
401049D

Input 220-240V~ Lm 1200  
Cons. 12W/mt Led SMD2835 120/mt

CRI >80 IP 65 IMB 1

**Accessori di montaggio per 401049**

401050 Coppia tappi

**€ 0,991**



IMB 500/100/10

401051 Clip montaggio

**€ 0,331**



IMB 375/125/25

401052 Connettore dritto

**€ 2,311**



IMB 100/50/10

401094 Connettore iniziale

**€ 6,468**



IMB 100/10

### 25W DRIVER

Dim. 85x58x28



IP 20 IMB 72/1

40068512 12V | 2,1A | 25W  
40068524 24V | 1,0A | 25W

Input 100-240V~

**€ 15,884**

### 36W DRIVER

Dim. 85x58x28



IP 20 IMB 72/1

40088812 12V | 3,0A | 36W  
40088824 24V | 1,5A | 36W

Input 100-240V~

**€ 15,831**

### 60W DRIVER SLIM

Dim. 139x55x28



IP 20 IMB 70/1

40068612 12V | 5,0A | 60W  
40068624 24V | 2,5A | 60W

Input 100-240V~

**€ 16,373**

### 100W DRIVER SLIM

Dim. 139x55x28



IP 20 IMB 40/1

40068712 12V | 8,3A | 100W  
40068724 24V | 4,16A | 100W

Input 100-240V~

**€ 23,533**

### 150W DRIVER SLIM

Dim. 178x61x28



IP 20 IMB 60/1

40066412 12V | 12,5A | 150W  
40066424 24V | 6,25A | 150W

Input 100-240V~

**€ 32,236**

### 250W DRIVER SLIM

Dim. 215x62x31



IP 20 IMB 44/1

40069612 12V | 20,0A | 250W  
40069624 24V | 10,0A | 250W

Input 175-240V~

**€ 46,609**

### 300W DRIVER SLIM

Dim. 215x62x31



IP 20 IMB 44/1

40099112 12V | 25,0A | 300W  
40099124 24V | 12,5A | 300W

Input 175-240V~

**€ 57,718**



[www.poliplastsrl.com](http://www.poliplastsrl.com)

### 15W DRIVER

Dim. 100x30x22

**€ 14,740**



IP 40 IMB 210/1

40099212 12V | 1,0A | 15W  
40099224 24V | 0,5A | 15W

Input 100-240V~

### 35W DRIVER

Dim. 145x38x22

**€ 25,811**



IP 40 IMB 80/1

40099312 12V | 3,0A | 35W  
40099324 24V | 1,5A | 35W

Input 100-240V~

### 50W DRIVER

Dim. 176x42x24

**€ 33,180**



IP 40 IMB 100/1

40099412 12V | 4,0A | 50W  
40099424 24V | 2,0A | 50W

Input 100-240V~

### 100W DRIVER

Dim. 180x30x23

**€ 41,250**



IP 40 IMB 100/1

40107012 12V | 8,3A | 100W  
40107024 24V | 4,16A | 100W

Input 100-240V~

### 150W DRIVER

Dim. 222x30x23

**€ 46,750**



IP 40 IMB 50/1

40107412 12V | 12,5A | 150W  
40107424 24V | 6,25A | 150W

Input 100-240V~

### 200W DRIVER

Dim. 222x30x23

**€ 55,000**



IP 40 IMB 50/1

40107512 12V | 16,66A | 200W  
40107524 24V | 8,33A | 200W

Input 100-240V~

### 250W DRIVER

Dim. 256x45x23

**€ 60,500**



IP 40 IMB 50/1

40107612 12V | 20,8A | 250W  
40107624 24V | 10,4A | 250W

Input 100-240V~

**60W DRIVER DIMMERABILE**

Dim. 187x49x29

NEW



**€ 56,375**

0-10V TRIAC IP 20 IMB 50/1

Input 170-264V~

40108724 24V | 2,5A | 60W

**100W DRIVER DIMMERABILE**

Dim. 230x49x29

NEW



**€ 60,500**

0-10V TRIAC IP 20 IMB 50/1

Input 170-264V~

40108824 24V | 4,15A | 100W

**150W DRIVER DIMMERABILE**

Dim. 287x49x29

NEW



**€ 68,750**

0-10V TRIAC IP 20 IMB 50/1

Input 170-264V~

40108924 24V | 6,25A | 150W

**60W DRIVER IP67**

Dim. 185x40x30

**€ 41,296**



IP 67 IMB 72/1

Input 100-240V~

40088912 12V | 5,0A | 60W

40088924 24V | 2,5A | 60W

**100W DRIVER IP67**

Dim. 172x70x40

**€ 70,142**



IP 67 IMB 72/1

Input 100-240V~

40089012 12V | 8,3A | 100W

40089024 24V | 4,16A | 100W

**150W DRIVER IP67**

Dim. 208x60x33

**€ 80,833**



IP 67 IMB 35/1

Input 100-240V~

40089112 12V | 12,5A | 150W

40089124 24V | 6,25A | 150W



**9W 1100Lm**

400801X

**GIORGIA**  
**€ 9,769**

Dim. 300x75x25

**TECNOLOGIA TRICOLOR** IP 20 IMB 20/1

**8W 920Lm**

Dim. 584X22X30

400995CCT

**VERONICA**  
**€ 23,364**

IP 20 IMB 30/1

**18W 2100Lm**

400802X

**GIORGIA**  
**€ 14,520**



Dim. 600x75x25

**TECNOLOGIA TRICOLOR** IP 20 IMB 20/1

**10W 1150Lm**

Dim. 884X22X30

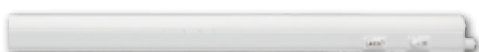
400996CCT

**VERONICA**  
**€ 29,391**

IP 20 IMB 30/1

**27W 3400Lm**

400803X

**GIORGIA**  
**€ 19,536**

Dim. 900x75x25

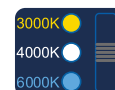
**TECNOLOGIA TRICOLOR** IP 20 IMB 20/1

**14W 1610Lm**

Dim. 1184X22X30

400997CCT

**VERONICA**  
**€ 30,764**



IP 20 IMB 30/1

**36W 4050Lm**

400804X

**GIORGIA**  
**€ 24,816**

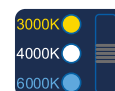
Dim. 1200x75x25

**TECNOLOGIA TRICOLOR** IP 20 IMB 10/1

**18W 2070Lm**

Dim. 1484X22X30

400998CCT

**VERONICA**  
**€ 38,096**

IP 20 IMB 30/1

**48W 5700Lm**

400805X

**GIORGIA**  
**€ 31,416**

Dim. 1500x75x25

**TECNOLOGIA TRICOLOR** IP 20 IMB 10/1

**48W 5280Lm**

401053



Dim. 1200x72x80

GIANNA  
€ 55,609

IP 65 IMB 10

**60W 6600Lm**

401054



Dim. 1500x72x80

GIANNA  
€ 68,158

IP 65 IMB 10



**CABLATA PER TUBI A LED**

400755-118



Dim. 660x69x78mm

OFELIA  
€ 12,960

IP 65 IMB 10

**CABLATA PER TUBI A LED**

400755-218



Dim. 660x99x78mm

OFELIA  
€ 16,029

IP 65 IMB 10

**CABLATA PER TUBI A LED**

400755-136



Dim. 1260x69x78

OFELIA  
€ 18,718

IP 65 IMB 10

**CABLATA PER TUBI A LED**

400755-236



Dim. 1260x99x78

OFELIA  
€ 23,524

IP 65 IMB 10

**CABLATA PER TUBI A LED**

400755-158



Dim. 1560x69x78

OFELIA  
€ 23,818

IP 65 IMB 10

**CABLATA PER TUBI A LED**

400755-258



Dim. 1560x99x78

OFELIA  
€ 28,860

IP 65 IMB 10

**4W 500Lm**

Dim. 230x80x27

**SOLEIL**  
**€ 27,627**

 401014C 

 Cover bianca  
 inclusa

IP 65 IMB 20/1

**4W 500Lm**

Dim. 230x80x27mm

**SOLEIL**  
**€ 30,118**

401014X

 Cover bianca  
 inclusa IP 65 IMB 20/1

**2W 220Lm**

Dim. 230x80x27mm

**PALMIRA**  
**€ 27,627**

 401026C 

 Cover bianca  
 inclusa

IP 65 IMB 20/1

**2W 220Lm**

Dim. 230x80x27mm

**PALMIRA**  
**€ 30,118**

401026X

 Cover bianca  
 inclusa IP 65 IMB 20/1

**6W 780Lm**

Dim. 255x90x30

**GILDA**  
**€ 31,578**

 401013C 

 Cover bianca  
 inclusa  
 Luce bidirezionale

IP 65 IMB 20/1

**6W 780Lm**

Dim. 255x90x30

**TERESA**  
**€ 33,082**

 401027C 

 Cover bianca  
 inclusa

IP 65 IMB 20/1

[www.poliplastsrl.com](http://www.poliplastsrl.com)
**8W 1000Lm**

Dim. 170x80x46

**EMILY**  
**€ 37,064**

 401017BIX   
 401017NEX 

Luce bidirezionale IP 65 IMB 20/1

**6W 620Lm**

Dim. 170x120x48

**MANOLA**  
**€ 33,331**

 401016CBI   
 401016CNE 

Luce bidirezionale

IP 65 IMB 20/1

**6W 650Lm**

Dim. 140x130x40

**MARICLA**  
**€ 30,693**

 401015CBI   
 401015CNE 

Luce bidirezionale

IP 65 IMB 20/1



**GU10**

**FABIANA**  
**€ 15,951**

401020BI  
 401020NE



Dim. 92x90x70

IP 44 IMB 20/1

**GU10**

**ADRIANA**  
**€ 21,738**

401032BI ○  
 401032NE ●



Dim. 110x110x85mm

IP 65 IMB 24/1

**GU10**

**ALBA**  
**€ 18,011**

401034BI ○  
 401034NE ●



Dim. 92x70x90mm

IP 54 IMB 20/1

**2xGU10**

**AURORA**  
**€ 18,700**

401021BI ○  
 401021NE ●

Luce bidirezionale



Dim. 160x92x70

IP 44 IMB 20/1

**2xGU10**

**BERENICE**  
**€ 29,189**

401033BI ○  
 401033NE ●

Luce bidirezionale



Dim. 110x85x195mm

IP 65 IMB 20/1

**2xGU10**

**LARA**  
**€ 19,873**

401035BI ○  
 401035NE ●

Luce bidirezionale



Dim. 92x70x160mm

IP 54 IMB 20/1

**GU10**

**ALDA**  
**€ 17,600**

401022BI ○ □  
 401022NE ● □



Dim. 194x110xØ60

IP 44 IMB 20/1

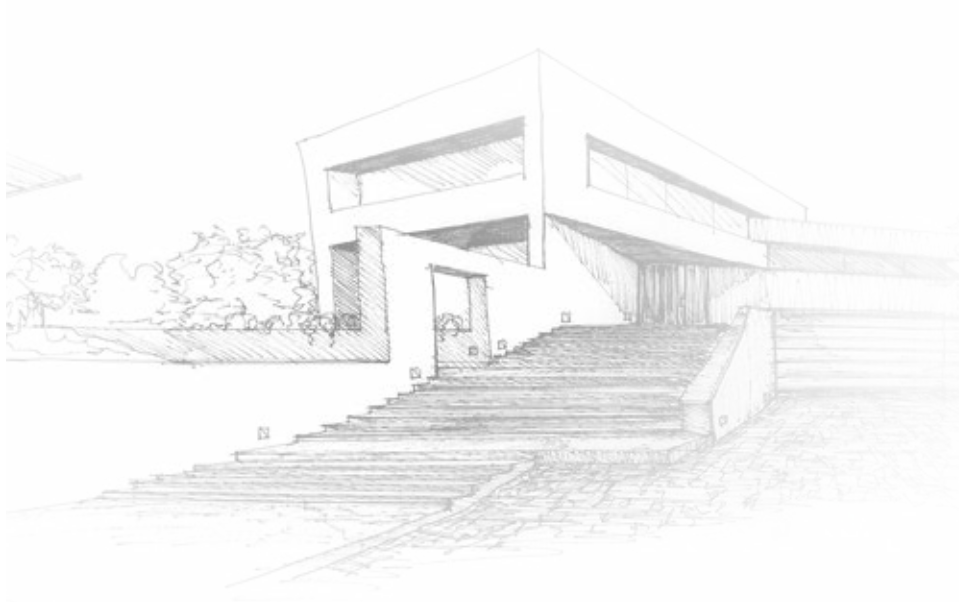

**OLIVIA**  
**NEW** € 121,000

401105BI ○  
 401105NE ●

**2xE27**



Dim. 2107x600mm

IP 44 IMB 1

**E27**

**NEW**

**VILMA**  
 € 23,100

401103BI ○  
 401103NE ●



Dim. 311X230x190

IP 44 IMB 6/1

**E27**

**NEW**

**LILIANA**  
 € 23,650

401104BI ○  
 401104NE ●



Attacco palo  
 ø60

Dim. 276X190X190

IP 44 IMB 6/1

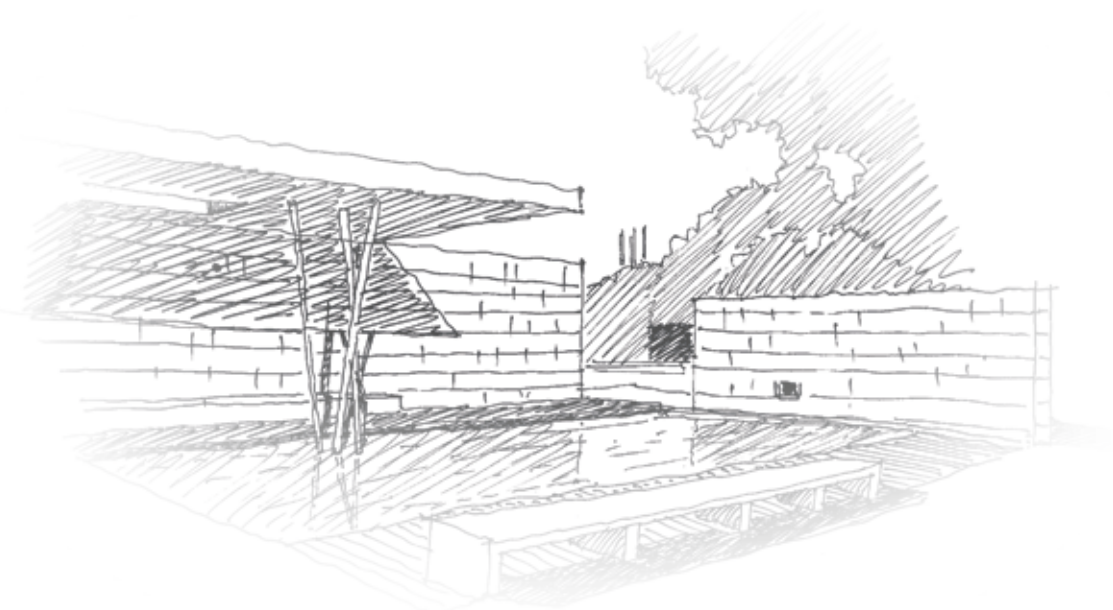



Dim. 2216x578mm

**LORETTA**  
**€ 180,851**

- 401028BI
- 401028NE
- 401028NO

**3xE27**



**E27**

**NEW**

**LINDA**  
**€ 20,350**

- 401085BI
- 401085NE
- 401085NO



Dim. Ø222x878

IP 44 IMB 6/1

**E27**

**AMANDA**  
**€ 24,640**

- 401024BI
- 401024NE
- 401024NO



Dim. Ø222x386  
 Foro x palo Ø60

IP 44 IMB 6/1

**E27** Lanterna  
 in polipropilene

**REVERSIBILE**

**MIRELLA**  
**€ 26,769**

Dim. 260x195x420

- 400423BI
- 400423NE
- 400423NO

Vetri trasparenti



Montato con  
 braccio a sostegno



Montato con  
 braccio a sospensione

Dim. 261x222x402

IP 44 IMB 6/1



**GU10**

**BERTA**  
**€ 22,953**

401029BI ○  
 401029NE ●



Dim. 118x92xØ69mm

IP 65 IMB 20/1

**GU10**

**NINA**  
**€ 60,862**

401030BI ○  
 401030NE ●



Dim. 800x251xØ150mm

IP 65 IMB 6/1

**2xGU10**

**ZOE**  
**€ 77,631**

401031BI ○  
 401031NE ●



Dim. 800x352xØ150mm

IP 65 IMB 6/1

**E27**

**IRENE**  
**€ 24,751**

401019



Dim. 260x136xØ91

IP 54 IMB 20/1

**E27**

**NORA**  
**€ 57,751**

401018



Dim. Ø160x1000

IP 54 IMB 4/1

**E27**

**NINFA**  
**€ 37,644**

400422BI ○  
 400422NE ●  
 400422NO ●



Dim. 330xØ220x420

IP 44 IMB 4/1

**10xE27** NEW

**THEA**  
**€ 52,525**

401086NE



Dim. 7,5mt + 2,5mt (cavo)

IP 65 IMB 10/1



**10W 800Lm**

- ■ 400869WBI
- □ 400869CBI
- ■ 400869DBI
- ■ 400869WNE
- □ 400869CNE
- ■ 400869DNE

**VICKY**  
**€ 6,156**
**IMB** **IP**  
**60/1** **65**

Dim. 95x69x23

**20W 1600Lm**

- ■ 400870WBI
- □ 400870CBI
- ■ 400870DBI
- ■ 400870WNE
- □ 400870CNE
- ■ 400870DNE

**VICKY**  
**€ 10,022**
**IMB** **IP**  
**40/1** **65**

Dim. 108x81x24

**30W 2550Lm**

- ■ 400871WBI
- □ 400871CBI
- ■ 400871DBI
- ■ 400871WNE
- □ 400871CNE
- ■ 400871DNE

**VICKY**  
**€ 14,956**
**IMB** **IP**  
**20/1** **65**

Dim. 143x108x24

**50W 4250Lm**

- ■ 400872WBI
- □ 400872CBI
- ■ 400872DBI
- ■ 400872WNE
- □ 400872CNE
- ■ 400872DNE

**VICKY**  
**€ 18,489**
**IMB** **IP**  
**10/1** **65**

Dim. 187x140x24

**100W 8500Lm**

- ■ 400893WBI
- □ 400893CBI
- ■ 400893DBI
- ■ 400893WNE
- □ 400893CNE
- ■ 400893DNE

**VICKY**  
**€ 36,689**
**IMB** **IP**  
**5/1** **65**

Dim. 274x197x28

**150W 13000Lm**

- □ 400938CBI
- ■ 400938DBI
- □ 400938CNE
- ■ 400938DNE

**VICKY**  
**€ 92,816**
**IMB** **IP**  
**5/1** **65**

Dim. 305x233x31

**200W 17000Lm**

- □ 400939CBI
- ■ 400939DBI
- □ 400939CNE
- ■ 400939DNE

**VICKY**  
**€ 127,773**
**IMB** **IP**  
**4/1** **65**

Dim. 358x277x33

**30W 2550Lm**

- □ 400940CBI
- ■ 400940DBI
- □ 400940CNE
- ■ 400940DNE

**VICKY**  
**€ 31,200**
**IMB** **IP**  
**20/1** **65**

Dim. 143x178x55



**50W 5000Lm**

- 401055C
- 401055D

AGATA  
**€ 73,889**



Attacco palo  
Ø60

Dim. 160x458  
Attacco palo Ø60

IP 65 IMB 5/1

**100W 10000Lm**

- 401056C
- 401056D

AGATA  
**€ 98,889**



Attacco palo  
Ø60

Dim. 200x528  
Attacco palo Ø60

IP 65 IMB 5/1

Accessorio di montaggio a parete  
per 401055C-401056C

**€ 11,000**

401058



IMB 15/1

**180W 2800Lm**

- 401057C

Solar lamp

VALERIA  
**€ 249,911**

Attacco palo  
Ø60



Dim. 330X650X135

IP 65 IMB 1

**20W 2300Lm**

 401059Z  
 Dual color 4000K - 6000K

 401059H  
 Dual color 3000K - 4000K

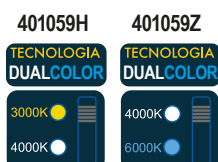
 Attacco palo  
 Ø60

IP 65 IMB 1

Dim. Ø400X120 - Attacco palo Ø60

**GIULIA**  
**€ 126,356**

 Lampione solare  
 Dualcolor, con attacco  
 per palo Ø60.  
 Con sensore crepuscolare.

**15W 2200Lm** **NEW**

 401060Z  
 Dual color 4000K - 6000K

 401060H  
 Dual color 3000K - 4000K

 Attacco palo  
 Ø60

 Palo in alluminio  
 diam. 76

 401078  
**€ 34,650**

 Accessorio per  
 montaggio a parete

 401061  
**€ 10,560**

 Accessorio per  
 montaggio a suolo

 401062  
**€ 10,560**
**MARZIA**  
**€ 96,730**

 Lampione solare  
 Dualcolor, con attacco  
 per palo Ø60.  
 Con sensore crepuscolare  
 e di prossimità.

IP 65 IMB 4/1

Dim. Ø257X190

**6W 900Lm** **NEW**
 401083CBI  
 401083CNE

 Pannello solare integrato  
 nella parte superiore

Dim. 230x42,7x97

IP 65 IMB 24/1

**ALESSIA**  
**€ 35,816**

 Con sensore crepuscolare  
 e di prossimità.

**15W 2000Lm** **NEW**

 401084Z  
 Dual color 4000K - 6000K

Dim. 294x236x77

 Pannello solare integrato  
 nella parte superiore

IP 65 IMB 6/1

**MOLLY**  
**€ 95,832**

 Con sensore crepuscolare  
 e di prossimità.



**50W 550Lm**

401007C

Solar lamp

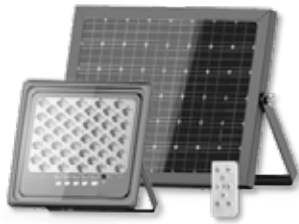

Dim. proiettore 205X202X53  
Dim. pannello 290X210X21,5

IP 65 IMB 2/1

VICKY  
**€ 77,667**

**100W 1050Lm**

401008C

Solar lamp



Dim. proiettore 233X235X53  
Dim. pannello 370X285X21,5

IP 65 IMB 2/1

VICKY  
**€ 113,311**

**200W 1650Lm**

401009C

Solar lamp

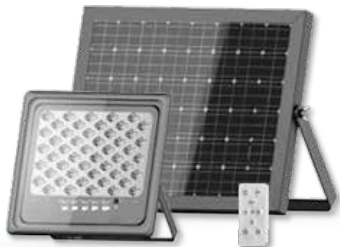

Dim. proiettore 275x270x53  
Dim. pannello 400x370x25

IP 65 IMB 2/1

VICKY  
**€ 148,689**

Cavo 2,5mt per proiettori solari

**NEW**

401082

**€ 10,725**



IMB 50/1

**300W 2450Lm**

401036C

Solar lamp



Dim. proiettore 323x315x53  
Dim. pannello 500x370x30

IP 65 IMB 2/1

VICKY  
**€ 213,667**

**12W 1500Lm**

401064CBI

401064CNE

Solar lamp

VERA  
**€ 63,251**

con sensore di movimento



Dim. 178X290X140

IP 54 IMB 8/1

### E27

**MALENA**  
**€ 46,667**

- 401037BI ○
- 401037NE ●
- 401037AN ●
- 401037CO ●

Schermo  
 policarbonato



Nero



Antracite



Corten

Dim. 250x110x103

IP 54 IMB 12/1

### 2xE27

**SOFIA**  
**€ 74,250**

- 401079BI ○
- 401079NE ●
- 401079AN ●
- 401079CO ●

Schermo  
 policarbonato



Nero



Antracite



Corten

Dim. 230x230x100

IP 54 IMB 8/1

### GU10

**VANNA**  
**€ 30,360**

401005



Dim. 102xØ65

IP 65 IMB 24/1

### GU10

**ADELE**  
**€ 25,756**

400877



Dim. Ø100x120

IP 67 IMB 30/1 090

### GU10

**ADELE**  
**€ 32,493**

400878



Dim. 100x100x120

IP 67 IMB 30/1 090



**3W 180Lm**

Dim. 32xØ32



Modello nero    Modello bianco    Modello alluminio

**AIDA**  
**€ 7,920**

- |             |             |             |
|-------------|-------------|-------------|
| 401048WBI ○ | 401048WNE ● | 401048WNE ● |
| 401048CBI ○ | 401048CNE ● | 401048CNE ● |
| 401048DBI ○ | 401048DNE ● | 401048DNE ● |
|             | 401048WAL ○ | 401048WAL ○ |
|             | 401048CAL ○ | 401048CAL ○ |
|             | 401048DAL ○ | 401048DAL ○ |

220-240 ~ IP 20 IMB 100/10/1 028

**3W 270Lm** **NEW**

Dim. 30XØ32



Con tre cornici supplementari incluse

**ZORA**  
**€ 8,855**

401081X



220-240 ~ IP 65 IMB 100/10/1 035

**0,2W 6Lm**

Dim. 32XØ15



CIELO STELLATO

**ALMA**  
**€ 8,384**

- |             |             |
|-------------|-------------|
| 400908WAL ○ | 400908WAL ○ |
| 400908CAL ○ | 400908CAL ○ |
| 400908DAL ○ | 400908DAL ○ |
| 400908WBI ○ | 400908WBI ○ |
| 400908CBI ○ | 400908CBI ○ |
| 400908DBI ○ | 400908DBI ○ |

12V DC IP 67 IMB 200/1 009

Disponibile anche in BIANCO

**3W 250Lm**

Dim. 90X70X70



Disponibile anche in BIANCO

**FEDORA**  
**€ 45,564**

- |             |             |
|-------------|-------------|
| 400789WAL ○ | 400789WAL ○ |
| 400789CAL ○ | 400789CAL ○ |
| 400789DAL ○ | 400789DAL ○ |
| 400789WBI ○ | 400789WBI ○ |
| 400789CBI ○ | 400789CBI ○ |
| 400789DBI ○ | 400789DBI ○ |

220-240 ~ IP 54 IMB 40/1 054

**3W 250Lm**

Dim. 90X70X70



Disponibile anche in ALLUMINIO

**BICE**  
**€ 45,564**

- |             |             |
|-------------|-------------|
| 400790WAL ○ | 400790WAL ○ |
| 400790CAL ○ | 400790CAL ○ |
| 400790DAL ○ | 400790DAL ○ |
| 400790WBI ○ | 400790WBI ○ |
| 400790CBI ○ | 400790CBI ○ |
| 400790DBI ○ | 400790DBI ○ |

220-240 ~ IP 54 IMB 40/1 054

**3W 175Lm**

Dim. 65X40X40



Disponibile anche in BIANCO

**SVEVA**  
**€ 33,311**

- |             |             |
|-------------|-------------|
| 400791WAL ○ | 400791WAL ○ |
| 400791CAL ○ | 400791CAL ○ |
| 400791DAL ○ | 400791DAL ○ |
| 400791WBI ○ | 400791WBI ○ |
| 400791CBI ○ | 400791CBI ○ |
| 400791DBI ○ | 400791DBI ○ |

12V AC/DC IP 68 IMB 50/1 035

**3W 195Lm**

Dim. 70XØ40



Disponibile anche in BIANCO

**INES**  
**€ 33,311**

- |             |             |
|-------------|-------------|
| 400792WAL ○ | 400792WAL ○ |
| 400792CAL ○ | 400792CAL ○ |
| 400792DAL ○ | 400792DAL ○ |
| 400792WBI ○ | 400792WBI ○ |
| 400792CBI ○ | 400792CBI ○ |
| 400792DBI ○ | 400792DBI ○ |

12V AC/DC IP 68 IMB 50/1 035

**1,8W 80Lm**

Dim. 65X40X40



Disponibile anche in ALLUMINIO

**SVEVA**  
**€ 41,778**

- |             |     |
|-------------|-----|
| 400791YAL ○ | RGB |
| 400791YBI ○ | RGB |

12V AC/DC IP 68 IMB 50/1 035

**1,8W 80Lm**

Dim. 70XØ40



Disponibile anche in ALLUMINIO

**INES**  
**€ 41,778**

- |             |     |
|-------------|-----|
| 400792YAL ○ | RGB |
| 400792YBI ○ | RGB |

12V AC/DC IP 68 IMB 50/1 035

### 3W 250Lm

Punto luce adatto per Pozzetto a 3 posti

CON 2 CORNICI



**AMALIA**  
€ 23,896

- 400909W
- 400909C
- 400909D



Dim. 105X65X25

### 3W 225Lm

Punto luce adatto per Pozzetto a 3 posti

CON 2 CORNICI



**AMALIA**  
€ 25,393

400909X



Dim. 105X65X25

TECNOLOGIA TRICOLOR

### 3W 250Lm

Punto luce adatto per Pozzetto a 3 posti

CORNICE IN VETRO



**ELENA**  
€ 25,769

- 400999W
- 400999C
- 400999D



Dim. 107X67X51

### 3W 230Lm

Punto luce adatto per Pozzetto a 3 posti

CORNICE IN VETRO



**ELENA**  
€ 28,124

400999X



Dim. 107X67X51

TECNOLOGIA TRICOLOR

### 6W 300Lm

Punto luce adatto per Pozzetto 506

CORNICE IN VETRO

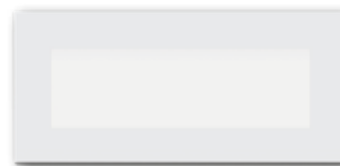

**ANNA**  
€ 35,970

401080X



Dim. 182X81X51

TECNOLOGIA TRICOLOR

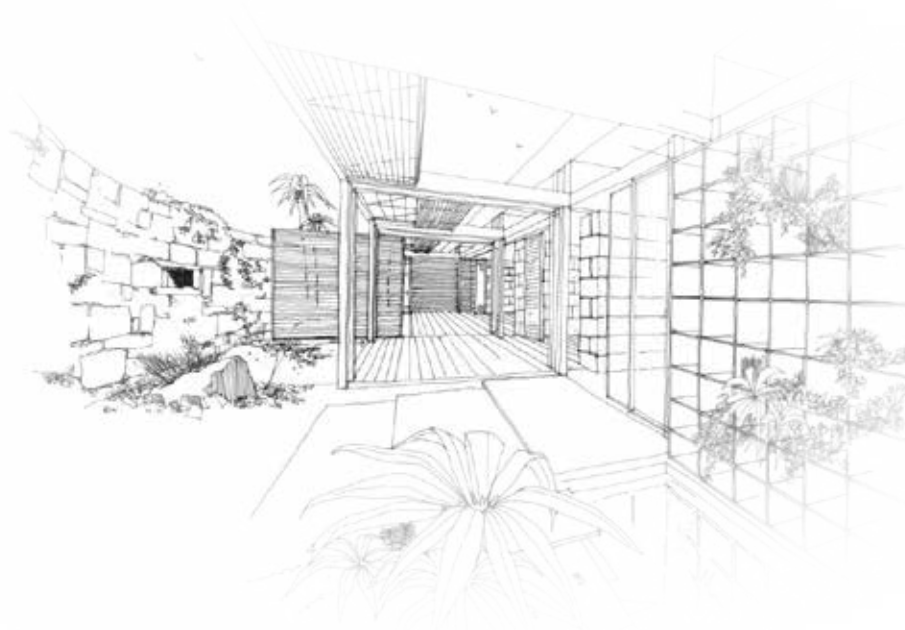

<p><b>20W</b> 500785W 500785C 500785D</p>  <p><b>GOCCIA</b> <b>€ 5,896</b></p> <p>Lumen 2300 IMB 100/25 Attacco E27</p> <p>200° Dim. Ø65x135</p>	<p><b>15W</b> 500767W 500767C 500767D</p>  <p><b>GOCCIA</b> <b>€ 3,644</b></p> <p>Lumen 1500 IMB 100/25 Attacco E27</p> <p>250° Dim. Ø60x123</p>	<p><b>22W</b> 500788W 500788C 500788D</p>  <p><b>GLOBO</b> <b>€ 11,520</b></p> <p>Lumen 2500 IMB 40/10 Attacco E27</p> <p>210° Dim. Ø120x165</p>
<p><b>12W</b> 500769W 500769C 500769D</p>  <p><b>GOCCIA</b> <b>€ 2,098</b></p> <p>Lumen 1160 IMB 100/25 Attacco E27</p> <p>250° Dim. Ø60x120</p>	<p><b>9W</b> 500768W 500768C 500768D</p>  <p><b>GOCCIA</b> <b>€ 1,844</b></p> <p>Lumen 820 IMB 100/25 Attacco E27</p> <p>250° Dim. Ø60x110</p>	<p><b>18W</b> 500784W 500784C 500784D</p>  <p><b>GLOBO</b> <b>€ 11,089</b></p> <p>Lumen 1890 IMB 40/10 Attacco E27</p> <p>210° Dim. Ø125x170</p>
<p><b>8W</b> 500789W 500789C 500789D</p>  <p><b>SFERA</b> <b>€ 2,538</b></p> <p>Lumen 806 IMB 100/25 Attacco E14</p> <p>250° Dim. Ø45x78</p>	<p><b>6W</b> 500770W 500770C 500770D</p>  <p><b>SFERA</b> <b>€ 1,791</b></p> <p>Lumen 510 IMB 100/25 Attacco E14</p> <p>250° Dim. Ø45x78</p>	
<p><b>8W</b> 500790W 500790C 500790D</p>  <p><b>SFERA</b> <b>€ 2,538</b></p> <p>Lumen 806 IMB 100/25 Attacco E27</p> <p>250° Dim. Ø45x76</p>	<p><b>6W</b> 500771W 500771C 500771D</p>  <p><b>SFERA</b> <b>€ 1,791</b></p> <p>Lumen 510 IMB 100/25 Attacco E27</p> <p>250° Dim. Ø45x76</p>	

<p><b>8W</b> 500791W 500791C 500791D</p>  <p><b>CANDELA</b> <b>€ 2,538</b></p> <p>Lumen 806 IMB 100/25 Attacco E14</p> <p>250° Dim. Ø37X110</p>	<p><b>6W</b> 500772W 500772C 500772D</p>  <p><b>CANDELA</b> <b>€ 1,791</b></p> <p>Lumen 510 IMB 100/25 Attacco E14</p> <p>250° Dim. Ø37X100</p>	<p><b>6W</b> 500773W 500773C 500773D</p>  <p><b>WIND</b> <b>€ 1,791</b></p> <p>Lumen 510 IMB 100/25 Attacco E14</p> <p>250° Dim. Ø37X117</p>
--	--	---

**11W**

500748W  
500748C



**SPOT R80**  
**€ 13,298**

Lumen  
1055

IMB 10 Attacco E27



Dim. Ø80X116

**8W**

500747W  
500747C



**SPOT R63**  
**€ 8,776**

Lumen  
820

IMB 10 Attacco E27



Dim. Ø63X97

**6W**

500746W  
500746C



**SPOT R50**  
**€ 5,364**

Lumen  
470

IMB 10 Attacco E14



Dim. Ø50X86

**10W**

500795W  
500795C  
500795D



**TUBOLARE**  
**€ 3,602**

Lumen  
1000

IMB 100/10 Attacco E27



Dim. Ø37X121

**10W**

500796W  
500796C  
500796D



**TUBOLARE**  
**€ 3,602**

Lumen  
1000

IMB 100/10 Attacco E14



Dim. Ø37X121

**11W**

500797W  
500797C  
500797D



**TUBOLARE**  
**€ 4,333**

Lumen  
1100

IMB 100/10 Attacco E27



Dim. Ø42X110

**11W**

500798W  
500798C  
500798D



**TUBOLARE**  
**€ 4,333**

Lumen  
1100

IMB 100/10 Attacco E14



Dim. Ø42X110

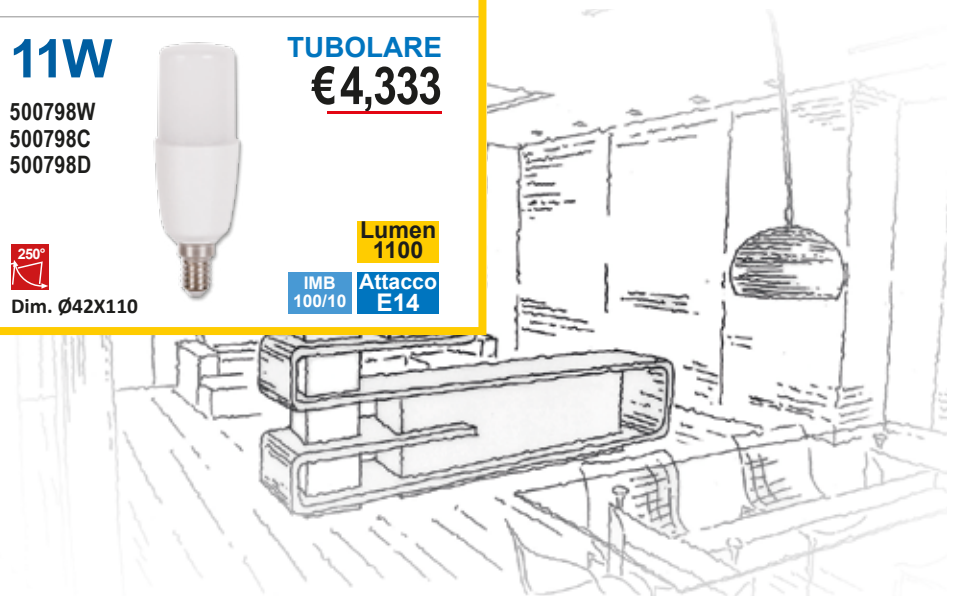

**40W**

NEW

500809C  
500809D



**OLIVA**  
**€ 22,484**

Lumen  
4800

IMB 20/5 Attacco E27



Dim. Ø90X220

**60W**

NEW

500810C  
500810D



**OLIVA**  
**€ 29,876**

Lumen  
7200

IMB 20/5 Attacco E27



Dim. Ø105X260

**2W**

 500779W  
 500779C  
 500779D

Dim. Ø24X33

**SPOT G4**  
**€ 4,558**

 12V  
 AC/DC  
 Lumen  
 220

 IMB  
 25 Attacco  
 G4

**1,8W**

 500781W  
 500781C  
 500781D

Dim. Ø9,5X37

**SPOT G4**  
**€ 5,416**

 12V  
 AC/DC  
 Lumen  
 180

 IMB  
 25 Attacco  
 G4

**2,5W**

 500780W  
 500780C  
 500780D

Dim. Ø16X41

**SPOT G4**  
**€ 7,658**

 12V  
 AC/DC  
 Lumen  
 180

 IMB  
 25 Attacco  
 G4

**3,5W**

 500802W  
 500802C  
 500802D

Dim. Ø16X56

**SPOT G4**  
**€ 5,213**

 12V  
 AC/DC  
 Lumen  
 340

 IMB  
 100/10 Attacco  
 G4

**2W**

 500786W  
 500786C  
 500786D

Dim. Ø14,5X60

**SPOT G9**  
**€ 5,102**

 220-  
 240V~  
 Lumen  
 200

 IMB  
 25 Attacco  
 G9

**3,5W**

 500782W  
 500782C  
 500782D

Dim. Ø16X49

**SPOT G9**  
**€ 6,436**

 220-  
 240V~  
 Lumen  
 350

 IMB  
 25 Attacco  
 G9

**4W**

 500803W  
 500803C  
 500803D

Dim. Ø14,5X60

**SPOT G9**  
**€ 5,280**

 220-  
 240V~  
 Lumen  
 450

 IMB  
 100/10 Attacco  
 G9

**2W**

 500783W  
 500783C  
 500783D

Dim. Ø22,5X51

**PERA E14**  
**€ 4,664**

 220-  
 240V~  
 Lumen  
 180

 IMB  
 20 Attacco  
 E14

**4,5W** **NEW**

 500812W  
 500812C

Dim. Ø16X78

**SPOT R7S**  
**€ 12,540**

 220-  
 240V~  
 Lumen  
 500

 IMB  
 100/10 Attacco  
 R7S

**8W** **NEW**

 500813W  
 500813C

Dim. Ø16X118

**SPOT R7S**  
**€ 16,500**

 220-  
 240V~  
 Lumen  
 900

 IMB  
 100/10 Attacco  
 R7S



**10W**

500794WCH  
Trasparente  
500794CCH  
Trasparente



Dim. Ø70X135

**GOCCIA**  
a filamento  
€ 5,851

Lumen  
1500  
IMB 25 Attacco  
E27

**8W**

500793WCH  
Trasparente  
500793CCH  
Trasparente



Dim. Ø60X107

**GOCCIA**  
a filamento  
€ 3,556

Lumen  
1055  
IMB 25 Attacco  
E27

**5W**

500761WCH  
Trasparente  
500761CCH  
Trasparente  
500761WOP  
Opale  
500761WSM  
Smerigliato



Dim. Ø45X77

**SFERA** a filamento  
500761WCH-CCH  
€ 2,924

500761WOP-WSM  
€ 3,251

Lumen  
550  
IMB 25 Attacco  
E14

**5W**

500724WCH  
Trasparente  
500724CCH  
Trasparente  
500724WOP  
Opale  
500724WSM  
Smerigliato



Dim. Ø35X97

**CANDELA** a filamento  
500724WCH-CCH  
€ 2,924

500724WOP-WSM  
€ 3,251

Lumen  
550  
IMB 25 Attacco  
E14

**5W**

500725WCH  
Trasparente  
500725CCH  
Trasparente  
500725WOP  
Opale  
500725WSM  
Smerigliato



Dim. Ø35X120

**WIND** a filamento  
500725WCH-CCH  
€ 2,924

500725WOP-WSM  
€ 3,251

Lumen  
550  
IMB 25 Attacco  
E14

**5W**

500764WCH  
Trasparente  
500764CCH  
Trasparente



Dim. Ø35X97

**TORTIGLIONE**  
a filamento  
€ 2,924

Lumen  
550  
IMB 25 Attacco  
E14

**8W**

500787WCH  
Trasparente



Dim. Ø125X175

**GLOBO**  
a filamento  
€ 11,251

Lumen  
1055  
IMB 10 Attacco  
E27

**2W**

NEW

500811W



Dim. Ø44X84

**PERA** a filamento  
€ 1,782

Lumen  
100  
IMB 50/10 Attacco  
E27

**TUBO LED T8  
IN VETRO**  
Ø28x602

 500738W  
500738C  
500738D

**Lumen  
900**  
Attacco  
G13/T8

**€ 4,269**

**TUBO LED T8  
IN VETRO**  
Ø28x907

 500804W  
500804C  
500804D

**Lumen  
1550**  
Attacco  
G13/T8

**€ 5,809**
**DF**  
>0,70  
**220°**  
**IMB  
15**

**TUBO LED T8  
IN VETRO**  
Ø28x1212

 500739W  
500739C  
500739D

**Lumen  
2000**  
Attacco  
G13/T8

**€ 5,567**

**TUBO LED T8  
IN VETRO**  
Ø28x1512

 500740W  
500740C  
500740D

**Lumen  
2640**  
Attacco  
G13/T8

**€ 7,576**
**FINTO STARTER**  
per Tubi Led T8-G13  
401063

**€ 0,936**

**IMB  
500/5**
**6W**

 500799W  
500799C  
500799D

**100°**

Dim. Ø50X56

**SPOT GU10**  
**€ 2,880**
**Lumen  
530**  
Attacco  
GU10

**IMB  
100/50/10**
**7W**

 500720W  
500720C  
500720D

**60°**

Dim. Ø50X55

**SPOT GU10**  
**€ 3,529**
**Lumen  
600**  
Attacco  
GU10

**IMB  
50/10**

**9W**

 500805W  
500805C  
500805D

**110°**

Dim. Ø50X56

**SPOT GU10**  
**€ 4,158**
**Lumen  
820**  
Attacco  
GU10

**IMB  
100/50/10**

**TECNOLOGIA TRICOLOR**

**14W** **NEW**

500806X

TECNOLOGIA TRICOLOR



Dim. Ø215X32

**LED CIRCOLARE T9**

**€ 16,016**

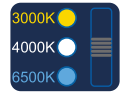

**Lumen 1400**

IMB 20 Attacco G10Q

**19W** **NEW**

500807X

TECNOLOGIA TRICOLOR



Dim. Ø300X32

**LED CIRCOLARE T9**

**€ 20,205**



**Lumen 1950**

IMB 20 Attacco G10Q

**24W** **NEW**

500808X

TECNOLOGIA TRICOLOR



Dim. Ø400X32

**LED CIRCOLARE T9**

**€ 33,572**



**Lumen 2500**

IMB 20 Attacco G10Q

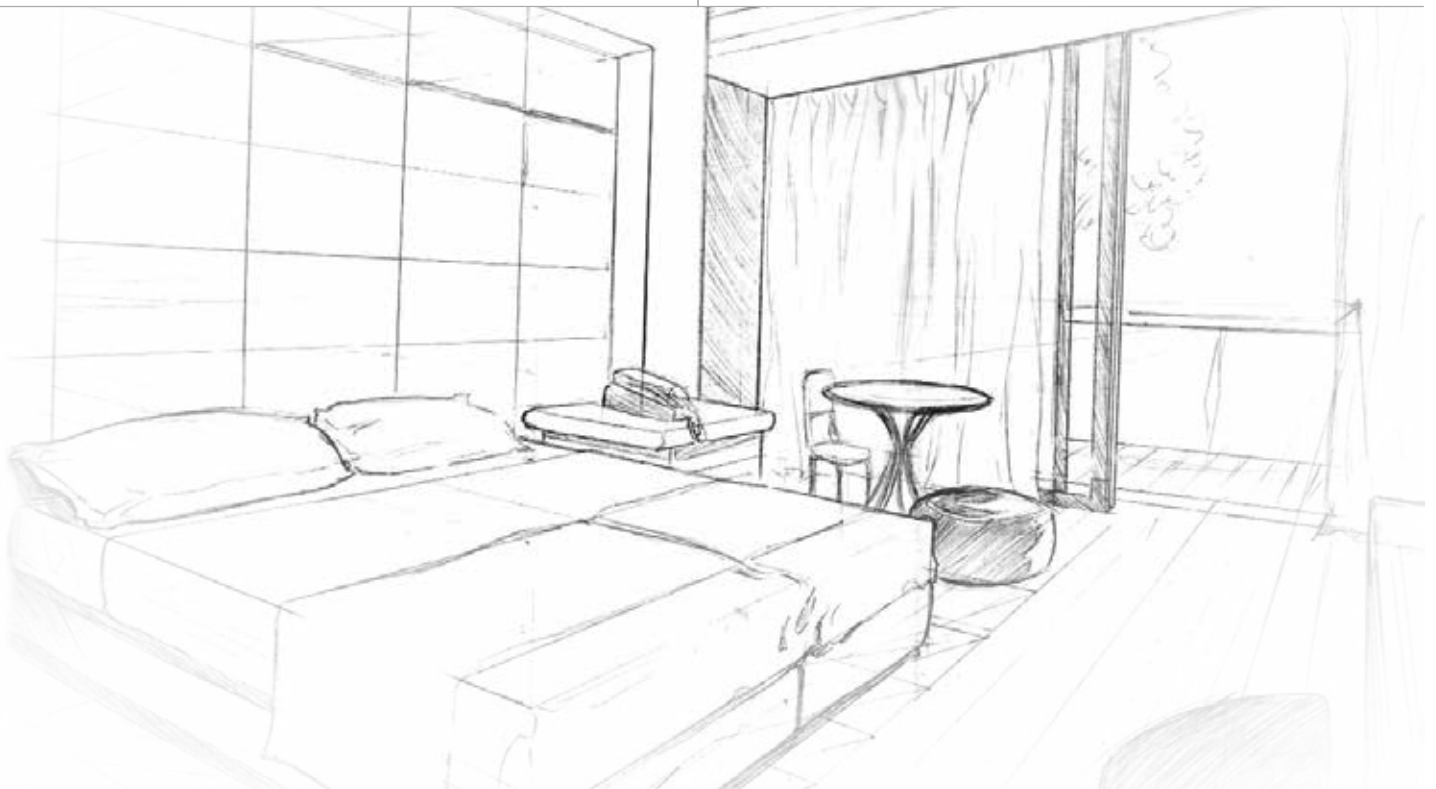

**8W** **NEW**

500814X

TECNOLOGIA TRICOLOR



Dim. Ø50X64



**SPOT GU10**

**€ 4,422**



**Lumen 720**

IMB 50/10 Attacco GU10

**10W** **NEW**

500815X

TECNOLOGIA TRICOLOR



Dim. Ø60x108



**GOCCIA**

**€ 4,884**



**Lumen 1000**

IMB 50/10 Attacco E27

Uscita assiale  
2P+T - 10A 250V~  
300600BI ○  
300600NE ●

**Spina dritta**  
**€ 0,867**



Uscita assiale  
2P+T - 16A 250V~  
300601BI ○  
300601NE ●

**Spina dritta**  
**€ 1,136**



Uscita assiale  
2P+T - 10A 250V~  
300602BI ○

**Spina 90°**  
**€ 0,980**



Uscita assiale  
2P+T - 16A 250V~  
300603BI ○

**Spina 90°**  
**€ 1,136**



Uscita assiale  
2P+T - 10A 250V~  
300621BI ○  
300621NE ●

**Spina 90°**  
**€ 1,236**



Uscita assiale  
2P+T - 16A 250V~  
300622BI ○  
300622NE ●

**Spina 90°**  
**€ 1,418**



Uscita assiale  
2P+T - 16A 250V~  
300618BI ○

**Schuko 90°**  
**€ 1,704**



Uscita assiale  
2P+T - 16A 250V~  
300619BI ○

**Schuko dritta**  
**€ 1,491**



Presca Schuko  
2P+T - 10/16A 250V~  
300620BI ○  
300620NE ●

**Schuko bivalente**  
**€ 1,929**



Presca  
2P+T - 10A 250V~  
300604BI ○  
300604NE ●

**Presca**  
**€ 1,222**



Presca  
2P+T - 10/16A 250V~  
300605BI ○  
300605NE ●

**Presca bivalente**  
**€ 1,464**



Spina 2P+T 16A  
presa 2P+T 10/16A 250V~  
300607BI ○  
300607NE ●

**Adattatore**  
**€ 1,647**



Spina schuko 2P+T 16A  
presa 2P+T 10/16A 250V~  
300616BI ○  
300616NE ●

**Adattatore**  
**€ 1,804**



Spina 2P+T 10A  
Presca Schuko 2P+T 250V~  
300610BI ○  
300610NE ●

**Adattatore**  
**€ 1,640**



Spina 2P+T 16A  
presa schuko 2P+T 250V~  
300611BI ○  
300611NE ●

**Adattatore**  
**€ 1,760**



Spina 2P+T 10A  
3 prese 2P+T 10A 250V~  
300617BI ○  
300617NE ●

**Adattatore**  
**€ 1,860**



Spina 2P+T 16A  
Prese 2P+T 10/16A 250V~  
300609BI ○  
300609NE ●

**Adattatore**  
**€ 1,898**



Spina 2P+T 16A  
presa schuko +  
2 prese 2P+T 10/16A 250V~  
300613BI ○  
300613NE ●

**Adattatore**  
**€ 2,682**



Adattatore rotante  
Spina 2P+T 10A 250V~  
Prese 2P+T 10/16A 250~  
1 Bipasso Schuko  
protezione da sovraccarico  
300614BI ○

**Adattatore**  
**€ 5,896**

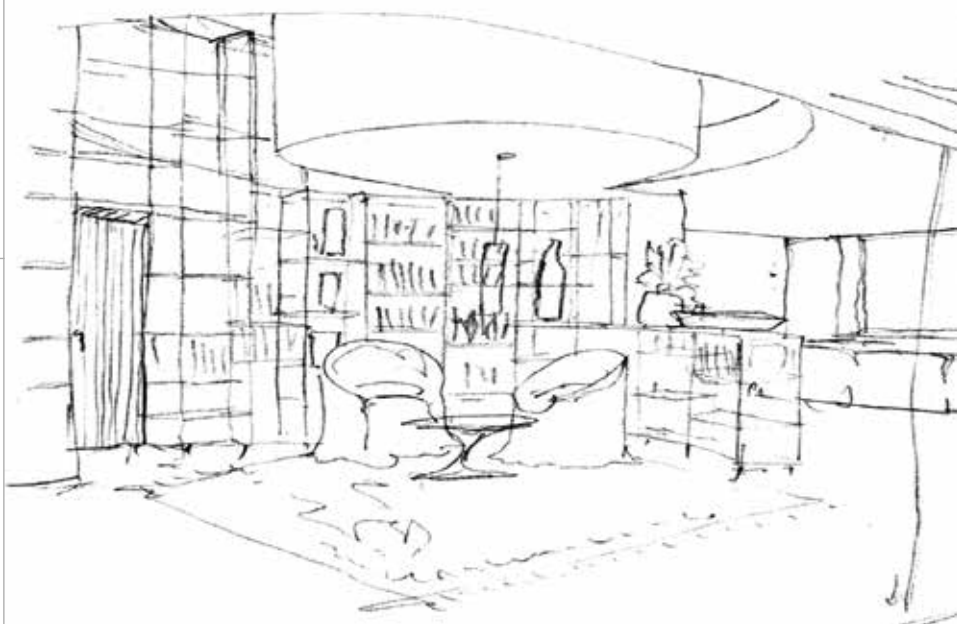

Spina 2P+T 16A  
3 prese, 2P+T 10/16A  
200603BI ○

**Pres. Mult.**  
**€ 5,609**



Spina 2P+T 16A  
4 prese, 2P+T 10/16A  
200604BI ○

**Pres. Mult.**  
**€ 6,091**



Spina 2P+T 16A  
3 schuko 2P+T 10/16A  
200613BI ○

**Pres. Mult. Schuko**  
**€ 8,624**



Protezione da Sovraccarico



Spina 2P+T 16A  
4 schuko 2P+T 10/16A  
200614BI ○

**Pres. Mult. Schuko**  
**€ 9,780**



Protezione da Sovraccarico



Spina 2P+T 16A  
5 schuko 2P+T 10/16A  
200615BI ○

**Pres. Mult. Schuko**  
**€ 10,929**



Protezione da Sovraccarico



Spina 2P+T 16A  
6 schuko 2P+T 10/16A  
200616BI ○

**Pres. Mult. Schuko**  
**€ 11,924**



Protezione da Sovraccarico







Cavo H05VV-F 3x0,75 Spina 2P+T 10A Presa 2P+T 10A 250V~ Lungh. 2 mt 100112BI ○ 	<b>Prolunga 10A</b> <b>€ 4,687</b>	Cavo H05VV-F 3x0,75 Spina 2P+T 10A Presa 2P+T 10A 250V~ Lungh. 3 mt 100103BI ○ 100103NE ● 	<b>Prolunga 10A</b> <b>€ 5,902</b>	Cavo H05VV-F 3x0,75 Spina 2P+T 10A Presa 2P+T 10A 250V~ Lungh. 5 mt 100105BI ○ 100105NE ● 	<b>Prolunga 10A</b> <b>€ 8,573</b>
Cavo H05VV-F 3x1,00 Spina 2P+T 16A Presa 2P+T 10/16A 250V~ Lungh. 3 mt 100203BI ○ 100203NE ● 	<b>Prolunga 16A</b> <b>€ 8,187</b>	Cavo H05VV-F 3x1,00 Spina 2P+T 16A Presa 2P+T 10/16A 250V~ Lungh. 5 mt 100205BI ○ 100205NE ● 	<b>Prolunga 16A</b> <b>€ 10,151</b>		
Spina 2P+T 10A 250V~ Lungh. 1,5 mt 100101BI ○ 100101NE ● 	<b>Interr. passante</b> <b>€ 4,469</b>	Spina 2P+T 10A 250V~ Lungh. 3 mt 100100 	<b>Telato 10A</b> <b>€ 8,593</b>	GU10 600120 	<b>Portalampada</b> <b>€ 0,622</b>
Lungh. 2 mt 100302BI ○ 100302NE ● 	<b>Prolunga TV</b> <b>€ 2,278</b>	Lungh. 3 mt 100303BI ○ 100303NE ● 	<b>Prolunga TV</b> <b>€ 2,600</b>	Lungh. 5 mt 100305BI ○ 100305NE ● 	<b>Prolunga TV</b> <b>€ 3,378</b>







Pacchi da 100pz.

Codice	Colore	Descrizione	Imballo	€ - Euro
00GRA4BI	Bianco	Graffetta 4mm	1000	0,0200 €
00GRA4BR	Marrone	Graffetta 4mm	1000	0,0200 €
00GRA4GR	Grigio	Graffetta 4mm	1000	0,0200 €
00GRA5BI	Bianco	Graffetta 5mm	1000	0,0222 €
00GRA5BR	Marrone	Graffetta 5mm	1000	0,0222 €
00GRA5GR	Grigio	Graffetta 5mm	1000	0,0222 €
00GRA6BI	Bianco	Graffetta 6mm	1000	0,0267 €
00GRA6BR	Marrone	Graffetta 6mm	1000	0,0267 €
00GRA6GR	Grigio	Graffetta 6mm	1000	0,0267 €
00GRA7BI	Bianco	Graffetta 7mm	1000	0,0289 €
00GRA7BR	Marrone	Graffetta 7mm	1000	0,0289 €
00GRA7GR	Grigio	Graffetta 7mm	1000	0,0289 €
00GRA8BI	Bianco	Graffetta 8mm	1000	0,0356 €
00GRA8BR	Marrone	Graffetta 8mm	1000	0,0356 €
00GRA8GR	Grigio	Graffetta 8mm	1000	0,0356 €
0GRA10BI	Bianco	Graffetta 10mm	1000	0,0489 €
0GRA10GR	Grigio	Graffetta 10mm	1000	0,0489 €

<p><b>Connettore F</b> Ø5,00 210245</p>  <p>IMB 5000/100</p>	<p><b>Connettore F</b> Ø6,75 210247</p>  <p>IMB 5000/100</p>	<p><b>Connettore F</b> doppio femmina 900206</p>  <p>IMB 2000/100</p>
<p><b>Spina coassiale</b> 75 Ohm Ø9,5 900203</p>  <p>IMB 2000/100</p>		<p><b>Presca coassiale</b> 75 Ohm Ø9,5 900207</p>  <p>IMB 2000/50</p>

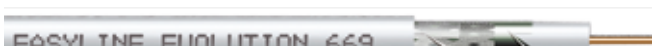

<p><b>Cavo coassiale</b> 75 Ohm ø3,70 EVO390</p>  <p>EASYLINE EVOLUTION 390</p> <p>IMB 500mt/100mt</p>	<p><b>Cavo coassiale</b> 75 Ohm ø5,00 H805A</p>  <p>EASYLINE H805A CLASS A+</p> <p>CLASSE A+</p> <p>IMB 250mt</p>
<p><b>Cavo coassiale</b> 75 Ohm ø5,00 EVO523</p>  <p>EASYLINE EVOLUTION 523</p> <p>IMB 750mt/150mt</p>	<p><b>Cavo coassiale</b> 75 Ohm ø6,70 H807A</p>  <p>EASYLINE H807A CLASS A+</p> <p>CLASSE A+</p> <p>IMB 200mt</p>
<p><b>Cavo coassiale</b> 75 Ohm ø6,65 EVO669</p>  <p>EASYLINE EVOLUTION 669</p> <p>IMB 500mt/100mt</p>	

**CORPO EXPO - Un unico espositore per tre diverse configurazioni**

**€ 84,800**

L'espositore è predisposto per accogliere diverse tipologie di confezioni, cambiando solamente la disposizione delle mensole in dotazione a seconda dell'ingombro del prodotto.

**Ingombro totale:**

L 64cm x P 41cm x H 176cm



**Configurazione**

**C**



**Espositore/tester per lampade**

500573

L'espositore è predisposto con i seguenti attacchi:  
2xE27, 2xE14, 1xGU10 e 1xG9

**Ingombro totale:**

L 43cm x P 16,5cm x H 26cm





# CORPORATE PANNELLI ESPOSITIVI

A-04



A-05



A-07



A-08



A-09

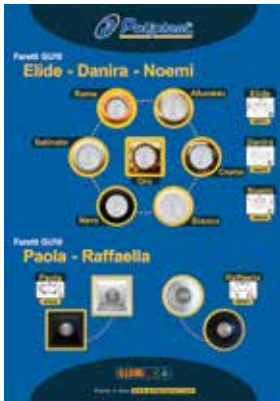

## Espositori 100x70cm

Spessore 10 mm (ingombro massimo con lampade 100x70x33)

I moduli sono realizzati in forex e sono predisposti per essere fissati a parete.

I prodotti esposti sono cablati e funzionanti.

A-14



A-18



A-19



A-20



A-21



A-22



A-23



A-24



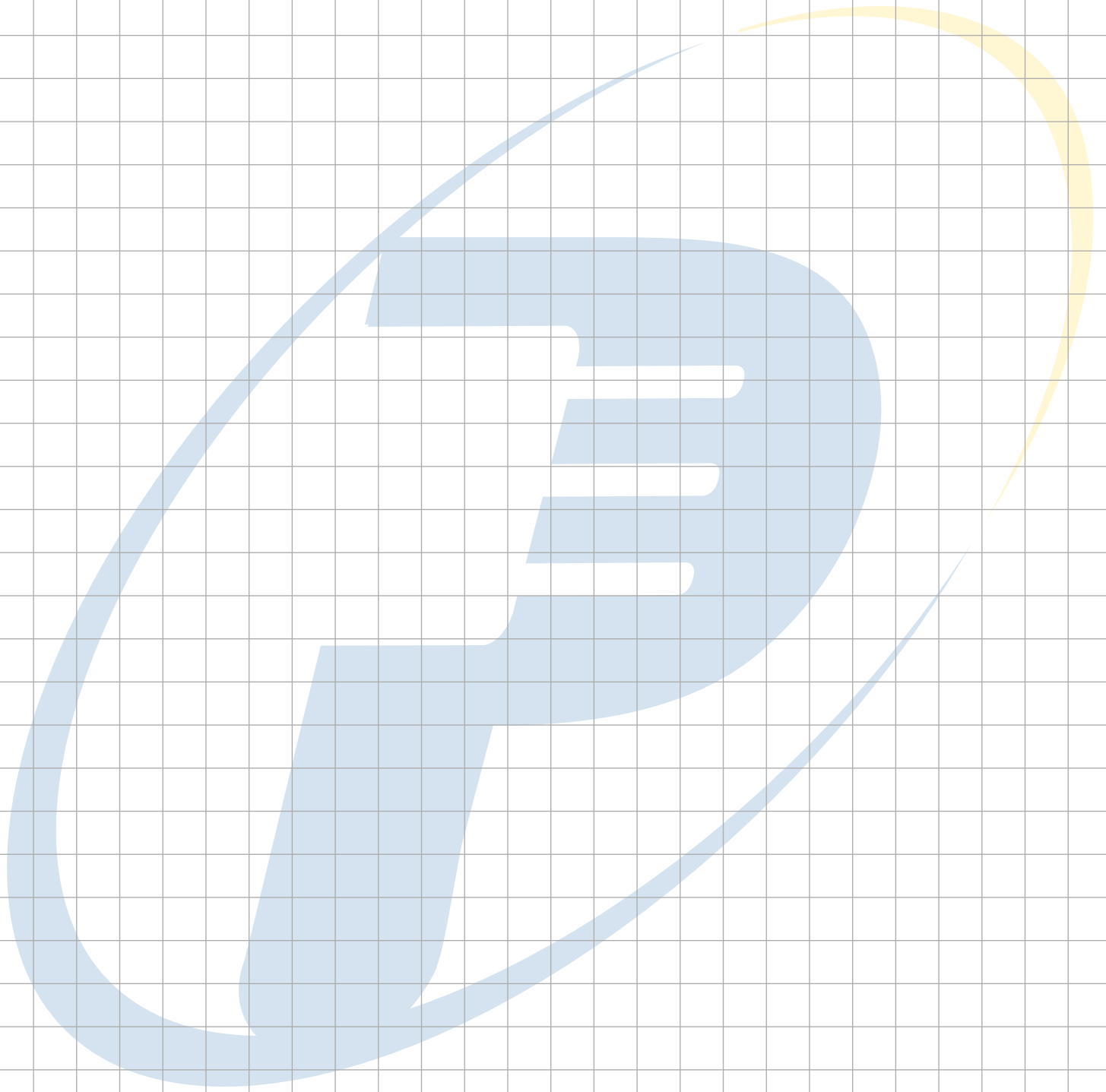

# CONDIZIONI GENERALI DI VENDITA

Il rapporto contrattuale conseguente al perfezionamento di ogni singolo ordine è retto dalle norme contenute nelle presenti condizioni generali di vendita. La parte acquirente rinuncia ad eventuali proprie condizioni generali di acquisto, salvo patto contrario specificatamente accettato per iscritto da POLIPLAST SRL. L'ordine di acquisto si intende perfezionato ed è irrevocabile per la parte acquirente quando la stessa parte acquirente riceve formale conferma da parte di POLIPLAST. Una volta confermato, l'ordine di acquisto non può essere annullato senza il preventivo consenso scritto di POLIPLAST. In questa eventualità è riconosciuta a POLIPLAST la facoltà di richiedere un congruo indennizzo per le spese e per gli oneri sostenuti in ragione dell'iniziata esecuzione dell'ordine.

I prezzi indicati nei cataloghi/listini di vendita hanno un carattere meramente indicativo e potranno subire variazioni nel corso della validità dei cataloghi/listini stessi in ragione dell'aumento dei costi di produzione.

Una volta confermati con le modalità stabilite dall'art. 2, i prezzi di vendita previsti nell'ordine diventeranno vincolanti, fatto salvo, in ogni caso, il verificarsi di aumenti dei costi di produzione imprevedibili e indipendenti dalla volontà di POLIPLAST. In questa eventualità POLIPLAST provvederà a comunicare gli aumenti dei prezzi alla parte acquirente indicandone le cause.

I termini di consegna, salvo esplicito patto contrario, hanno un carattere solamente indicativo. Nel caso in cui l'esecuzione dell'ordine fosse impedita dal verificarsi di circostanze di forza maggiore, dalla mancata regolarità dei rifornimenti di materie prima o da altre circostanze imprevedibili sopravvenute, i termini di consegna si intenderanno prorogati e i nuovi termini verranno stabiliti di comune accordo tra le parti.

La consegna dei prodotti alla parte acquirente avverrà EXW stabilimenti POLIPLAST SRL Catania (Italia). Il costo dell'imballaggio dei prodotti è a carico della parte acquirente e verrà fatturato al prezzo di costo.

La parte acquirente si impegna a verificare la conformità quantitativa e l'integrità dei colli inviati in contraddittorio con il vettore o con lo spedizioniere. Eventuali reclami per differenze quantitative o per colli danneggiati dovranno essere comunicati entro 8 giorni dal ricevimento della merce. Non sono ammesse restituzioni di prodotti se non preventivamente concordate e definite con POLIPLAST. Nei casi di resi autorizzati, i prodotti, dovranno essere restituiti in porto franco e imballo gratuito. In ogni caso non saranno prese in considerazione richieste di reso per articoli non presenti a listino in vigore al momento della richiesta.

La garanzia sui prodotti garantita al consumatore finale deve intendersi come garanzia convenzionale ai sensi dell'articolo 133 del Decreto Legislativo 6 settembre 2005, n. 206 (Codice del consumo). Il consumatore potrà pertanto far valere tali diritti nei confronti del venditore, alle condizioni e nei termini previsti dalla citata normativa e dalla presente garanzia convenzionale. I prodotti sono garantiti per un periodo di due anni dalla data di acquisto. Le parti e i componenti dei prodotti soggette al deterioramento a causa dell'uso quali, a titolo puramente esemplificativo e non esaustivo, le batterie, ecc. sono garantiti per un periodo di un anno dalla data di acquisto.

Il Consumatore finale deve denunciare per iscritto il difetto di conformità al venditore entro il termine di due mesi dalla data della scoperta, a pena di decadenza.

In caso di difetto di conformità dei prodotti venduti, il consumatore potrà richiedere la riparazione o sostituzione dello stesso. Qualora il rimedio richiesto dovesse risultare, ai sensi dell'art. 146 del Codice del Consumo, oggettivamente impossibile o eccessivamente oneroso, POLIPLAST provvederà al ripristino della conformità con rimedi alternativi.

In ogni caso, di difetti di conformità di lieve entità per il quale risulta essere oggettivamente impossibile o eccessivamente oneroso per POLIPLAST esperire i rimedi sopra previsti, non darà al consumatore finale il diritto di risolvere il contratto di vendita.

POLIPLAST garantisce la riparazione o sostituzione gratuita del bene non conforme. Spetta al consumatore, attraverso un documento di consegna rilasciato dal venditore o da altro documento probante (ricevuta fiscale, scontrino di cassa o similari, codice

prodotto, ordini, contratti, ecc.), che riporti il nominativo del venditore e la data in cui è stata effettuata la vendita, dimostrare che la presente garanzia deve intendersi ancora valida.

La garanzia di cui al presente articolo non opera in tutti i casi di uso improprio del bene e, in particolare, in caso di uso dello stesso nell'ambito di attività commerciali, imprenditoriali o professionali, per le quali rimangono valide le norme di cui all'articolo 1490 e ss. c.c.

Non vengono inoltre coperte dalla garanzia le non conformità dovute a negligenza o trascuratezza nell'uso (es. mancata osservanza delle istruzioni per il funzionamento dell'apparecchio), installazioni o manutenzioni operate da personale non autorizzato, danni da trasporto, ovvero dovute a circostanze che, comunque, non possono farsi risalire a difetti di fabbricazione e/o di conformità del bene. POLIPLAST declina ogni responsabilità per eventuali danni che possono, direttamente o indirettamente, derivare a persone, cose ed animali domestici in conseguenza della mancata osservanza di tutte le prescrizioni indicate nell'apposito libretto istruzioni e concernenti specialmente le avvertenze in tema di installazione uso e manutenzione del bene stesso.

I prodotti dovranno essere installati e/o usati nel rispetto delle loro caratteristiche tecniche e delle istruzioni impartite da POLIPLAST; inoltre dovranno essere installati e/o usati con l'osservanza delle disposizioni di sicurezza e con le disposizioni regolanti l'installazione e/o l'uso del materiale elettrico in vigore nel paese dove i prodotti sono installati e/o usati.

A tal fine la parte acquirente manleva espressamente POLIPLAST SRL da qualsivoglia responsabilità in ordine agli usi impropri, alla mancata osservanza delle norme di sicurezza, delle specifiche tecniche e delle istruzioni per l'uso. I prodotti non rispondenti alle norme e/o alle specifiche tecniche in vigore nell'Unione Europea saranno forniti solo alla parte acquirente che specifichi nell'ordine che il paese di destinazione non appartiene all'Unione Europea e dichiara di aver esperito tutti i controlli sulla compatibilità degli standard di sicurezza presenti nel paese extra U.E. cui sono destinati.

I pagamenti devono essere effettuati secondo le modalità comunicate da POLIPLAST SRL. Il mancato pagamento, anche parziale, delle fatture oltre il termine di scadenza fissato, produrrà l'immediata decorrenza degli interessi al tasso di cui al D.lgs. 9 ottobre 2002, n. 231, oltre all'addebito di eventuali spese bancarie e delle commissioni.

Il mancato pagamento a qualsiasi titolo autorizzerà POLIPLAST a sospendere ulteriori invii di materiale.

Ai sensi dell'art. 10 della legge 196/2003 la parte acquirente è informata che i dati personali a lei attinenti vengono inseriti nella banca dati POLIPLAST, essendo ciò necessario per il corretto svolgimento del rapporto contrattuale e per l'adempimento di alcune disposizioni di legge, oltre che per finalità di tipo statistico, commerciale, marketing, promozionali, di tutela del credito, di gestione e cessione del medesimo.

I dati personali della parte acquirente sono trattati attraverso strumenti automatizzati e cartacei da soggetti autorizzati, con l'impiego di misure di sicurezza atte a garantirne la riservatezza. I dati personali della parte acquirente possono essere comunicati ad enti pubblici, a società del gruppo, società di recupero crediti ovvero società, consorzi, o associazioni aventi finalità commerciali, di ricerca di mercato, di marketing.

Il titolare del trattamento è POLIPLAST SRL, cui la parte acquirente può rivolgersi per esercitare i diritti di cui all'articolo 13 della legge sopra citata.

A tal fine la parte acquirente è informata che in qualsiasi momento può avere accesso ai propri dati personali, richiedendone l'aggiornamento, la rettifica ovvero la cancellazione e/o opporsi al loro trattamento.

I diritti e le obbligazioni delle parti sono regolati dalla legge italiana e il Tribunale di Catania ha la competenza non esclusiva in ordine alle controversie che dovessero sorgere in relazione alla vendita dei prodotti.

La parte acquirente irrevocabilmente accetta la competenza del Tribunale di Catania qualora POLIPLAST SRL instauri la controversia presso questo tribunale.

***Poliplast***  
[www.poliplastsrl.com](http://www.poliplastsrl.com)

**Poliplast srl - Direzione e Uffici Amministrativi:**

Strada Passo del Fico snc, edificio a2 interno 5  
95121 Catania (Italy)

Tel. +39 095.7357530 pbx  
*info@poliplastsrl.com*

**Ordini clienti:** [commerciale01@poliplastsrl.com](mailto:commerciale01@poliplastsrl.com)

**Assistenza tecnica:** [assistentatecnica@poliplastsrl.com](mailto:assistentatecnica@poliplastsrl.com)