



www.poliplastsrl.com

LISTINO PRODOTTI

21 0000 6*16-120D-DC12V

20D-DC12V

2023

PLAFONIERE
27W 3240Lm

Dim. Ø330x65

NEW

MARLENA
€ 59,850

400952CCT

TECNOLOGIA TRICOLOR IP 66 IMB 5/1

27W 3240Lm

Dim. 330x330x65

NEW

MARLENA
€ 64,104

400953CCT

TECNOLOGIA TRICOLOR IP 66 IMB 5/1

15W 1700Lm

Dim. Ø220x66

MARTHA
€ 26,175

 400918B
 400918BW
 400918NW

IP 54 IMB 12/1

15W 1700Lm

Dim. 230x105x66

MARTHA
€ 21,895

 400919B
 400919NW

IP 54 IMB 12/1

24W 2000Lm

Dim. Ø280x75

ROSSELLA
€ 55,812

 400785BI
 400785BIW

IP 44 IMB 10/1

24W 2000Lm

Dim. 280x280x59

ROSSELLA
€ 57,442

 400786BI
 400786BIW

IP 44 IMB 10/1

12W 1160Lm

Dim. 128x128

DAISY
€ 16,044

 400832W
 400832C
 400832D

IP 20 IMB 20/1

20W 2050Lm

Dim. 178x178

DAISY
€ 25,289

 400833W
 400833C
 400833D

IP 20 IMB 20/1

30W 3200Lm

Dim. 238x238

DAISY
€ 34,261

 400834W
 400834C
 400834D

IP 20 IMB 20/1

9W 900Lm

Dim. 212x118x90

MEGAN
€ 17,148

 400811B
 400811N

IP 65 IMB 20/1



PLAFONIERE

12W 850Lm

Dim. 280x280x63

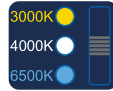

SHARON
€ 28,266
 400910CCT



TECNOLOGIA TRICOLOR IP 20 IMB 8/1

12W 1400Lm

Dim. Ø262X89



CINDY
€ 24,391
 400829CCT

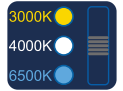

TECNOLOGIA TRICOLOR IP 20 IMB 8/1

18W 1260Lm

Dim. 330x330x71



SHARON
€ 36,260
 400911CCT



TECNOLOGIA TRICOLOR IP 20 IMB 8/1

18W 2100Lm

Dim. Ø322X104



CINDY
€ 30,265
 400830CCT



TECNOLOGIA TRICOLOR IP 20 IMB 8/1

24W 1680Lm

Dim. 375x375x71



SHARON
€ 39,688
 400912CCT



TECNOLOGIA TRICOLOR IP 20 IMB 8/1

24W 2800Lm

Dim. Ø372X110



CINDY
€ 37,116
 400831CCT



TECNOLOGIA TRICOLOR IP 20 IMB 8/1

E27



GINA2
€ 9,580

Dim. 175x120x100

20040B ○
 20040N ●

Schermo in vetro
 IP 44 IMB 20/1

E27



GINA1
€ 11,588

Dim. Ø185x105

2003B ○
 2003N ●

Schermo in vetro
 IP 44 IMB 20/1

E27



DORIS
€ 11,034

Dim. 175x120x100

2002B ○
 2002N ●

Schermo in vetro
 IP 44 IMB 20/1

E27



GRAZIA
€ 19,856

Dim. Ø220x115

2011B ○
 2011N ●

Schermo in vetro
 IP 44 IMB 20/1



GESSI

GU10

Dim. 80x80x50

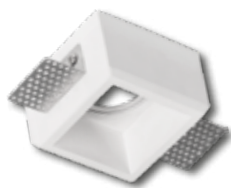
PIPER
 € 11,420

 400990
 35W max

GU10

Dim. Ø100x37

LUCIA
 € 9,501

 400720
 35W max

GU10

Dim. 100x100x37

NOVELLA
 € 9,501

 400721
 35W max

GU10

Dim. 120x120x60

GALATEA
 € 15,107

 400723
 35W max

GU10

Dim. 150x150x60

FOSCA
 € 27,368

 400726
 50W max

G53 AR111

Dim. 180x180x65

NIVES
 € 65,506

 400724
 75W max

2xGU10

Dim. 215x118x58

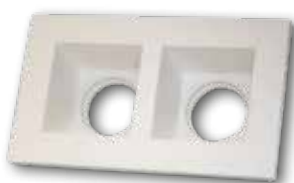
EDDA
 € 19,714

 400966
 2x35W max

GU10

Dim. 120x120x45

LUNA
 € 9,650

 400954
 50W max

GU10

Dim. 120x120x60

MIRA
 € 12,563

 400955
 50W max

GU10

Dim. Ø130x70

TECLA
 € 11,208

 400722
 35W max

GU10

Dim. Ø175x88

FULVIA
 € 34,937

 400734
 50W max

GU10

Dim. 120x120x58

CORA
 € 16,012

 400732
 50W max

2xE27

Dim. 250x250x90

MEDEA
 € 116,455

 400735
 2x75W max

www.poliplastsrl.com

GU10



ELSA
€ 70,018

400967
 35W max

Dim. 360x300x75



GU10



EVA
€ 33,311

400968
 35W max

Dim. 345x130x85



2xE14

Dim. 360x70x90
 Luce bidirezionale



SARA
€ 44,187

400975
 2x20W max



GU10

Dim. Ø70x90



FLORA
€ 19,034

400969
 9W max



GU10

Dim. 70x70x90



MARA
€ 19,714

400972
 9W max



2xE14

Dim. 400x100x160
 Luce bidirezionale



EMANUELA
€ 109,176

400733
 2x42W max



GU10

Dim. Ø70x110



GAIA
€ 21,073

400970
 9W max



GU10

Dim. 70x70x110



NICLA
€ 21,754

400973
 9W max



GU10

Dim. Ø70x130



LICIA
€ 23,114

400971
 9W max



GU10

Dim. 70x70x130



ROSA
€ 23,793

400974
 9W max



INCASSO
GU10 NEW
 Dim. 86x86x48

PAOLA
€ 9,549

 401010BI
 35W max

GU10 NEW
 Dim. 86x86x48

PAOLA
€ 9,549

 401010NE
 35W max

GU10 NEW
 Dim. 86x86x48

PAOLA
€ 9,549

 401010OR
 35W max

GU10 NEW
 Dim. ø81x73

RAFFAELLA
€ 7,885

 401011BI
 35W max

GU10 NEW
 Dim. ø81x73

RAFFAELLA
€ 7,885

 401011NE
 35W max

GU10 NEW
 Dim. ø81x73

RAFFAELLA
€ 7,885

 401011OR
 35W max

SPOT GU10
GU10 ELIDE **€ 4,736**

 400571BI-GU10 ○
 400571NE-GU10 ●

Dim. ø80x26

GU10 ELIDE
€ 5,289

 400571AL-GU10 ○
 400571CR-GU10 ○
 400571OR-GU10 ○
 400571ST-GU10 ○
 400571RA-GU10 ○

Dim. ø80x26

GU10 DANIRA **€ 5,934**

 400572BI-GU10 ○
 400572NE-GU10 ●

Dim. ø84x26

REGOLABILE
GU10 DANIRA
REGOLABILE
€ 6,678

 400572AL-GU10 ○
 400572CR-GU10 ○
 400572OR-GU10 ○
 400572ST-GU10 ○
 400572RA-GU10 ○

Dim. ø84x26

GU10 NOEMI **€ 6,583**

 400619BI-GU10 ○
 400619NE-GU10 ●

Dim. ø84x28

REGOLABILE
GU10 NOEMI
REGOLABILE
€ 7,409

 400619AL-GU10 ○
 400619CR-GU10 ○
 400619OR-GU10 ○
 400619ST-GU10 ○
 400619RA-GU10 ○

Dim. ø84x28

INCASSO
6.7W 700Lm
 Dim. ø87x47

NAOMI
€ 16,185

400958CCT

10W 1100Lm
 Dim. 58,5Xø105mm

ELISA
€ 26,705

401025CCT

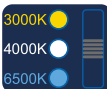

40W 5000Lm

Dim. 595x595



GIORDANA
€ 38,800

- 400765W-B
- 400765C-B
- 400765D-B

IP 20 IMB 5

40W 3600Lm

Dim. 595x595



GIORDANA
€ 58,462

- 400942C

IP 20 IMB 5

24W 3000Lm

Dim. 295x595



GIORDANA
€ 77,949

- 400766C-B
- 400766D-B

IP 20 IMB 5

40W 5000Lm

Dim. 295x1195



GIORDANA
€ 65,123

- 400767C-B
- 400767D-B

IP 20 IMB 5

Kit sospensione

per artt. 400921-765-766-767



GIORDANA
€ 9,021

400768

IMB 100/1

Kit cornice

in alluminio per artt. 400921-765-766-767

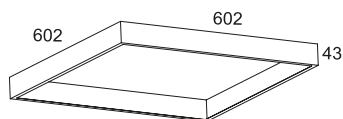

400769BI

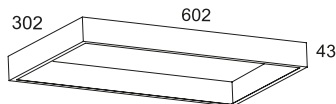

400769BI-A



400769BI-B

GIORDANA
€ 30,123

400769BI

GIORDANA
€ 26,806

400769BI-A

GIORDANA
€ 37,388

400769BI-B

- 400769BI IMB 20/1
- 400769BI-A IMB 10/1
- 400769BI-B IMB 20/1

20W 1800Lm

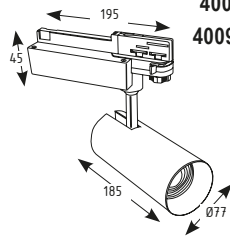

FIONA
€ 78,963

400987BI
 400987NE

IP 20 IMB 8/1

30W 2700Lm

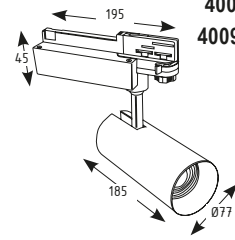

FIONA
€ 88,535

400988BI
 400988NE

IP 20 IMB 8/1

32W 2800Lm

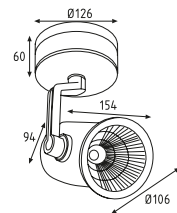

TELMA
€ 115,815

400782
 400782W

IP 20 IMB 8/1

18W 1200Lm

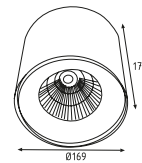

PALMA
€ 90,427

400784
 400784W

IP 20 IMB 18/1

Accessori 220-240V~



€ 72,872

400814B-2
 Binario elettr., allum., lungh. 2 mt, trifase



€ 11,093

400812B-SX
 Alimentazione SX per art. 400814



€ 18,226

400815B
 Giunto a L.90°

IOLANDA

- 400812B-DX IMB 100/1
- 400812B-SX IMB 100/1
- 400813B IMB 200/1
- 400814B-2 IMB 10/1
- 400815B IMB 100/1
- 400816B IMB 100/1
- 400817B-DX IMB 50/1
- 400818B IMB 40/1
- 400880 IMB 100/1

€ 11,093



400812B-DX
 Alimentazione DX per art. 400814

€ 1,601

400813B
 TAPPO DI CHIUSURA



400816B
 Giunto lineare
€ 18,226



€ 28,065

400817B-DX
 Giunto a T destro

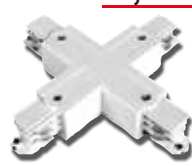

€ 37,237

400818B
 Giunto a X



€ 18,488

400880
 Kit sospensione (1,5 mt) per art. 400814

IP 20

E27

Ø100x200+cavo 1000



VIOLA
€ 56,435

400976

25W max

IP 20 IMB 6/1

E27

Ø210x230+cavo 1000



VIRGINIA
€ 75,674

400977

25W max

IP 20 IMB 6/1

GU10

Ø60x400
 +cavo 1200



ELODY
€ 50,403

400961BI

400961NE

50W max

IP 20 IMB 10/1

KIT PROFILI 400929

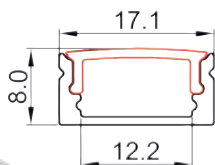

€ 16,754

Kit composto da:
1xProfilo
1xDiffusore
2xTappi
2xClips

IP 20 2 mt IMB 10

COVER 400844 - 400844B - 400844F

€ 9,607



Cover **Trasparente**
per art. 400929
400930 - 400932



Cover **Opale**
per art. 400929
400930 - 400932



Cover **Smerigliato**
per art. 400929
400930 - 400932

IP 20 2 mt IMB 10

KIT PROFILI 400930

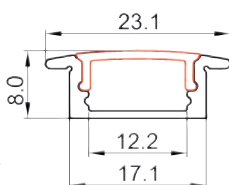

€ 16,754

Kit composto da:
1xProfilo
1xDiffusore
2xTappi

IP 20 2 mt IMB 10

COVER 401003 NEW

€ 52,800



Cover smerigliata
bobina 10mt
per 400929,
400930 - 400932

IP 20 10 mt IMB 1

KIT PROFILI 400931

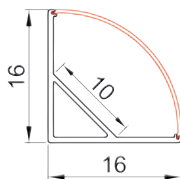

€ 17,760

Kit composto da:
1xProfilo
1xDiffusore
2xTappi
2xClips

IP 20 2 mt IMB 8

KIT PROFILI 400986

€ 36,989

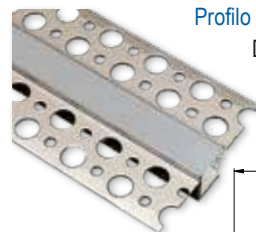

Profilo con alette per cartongesso
Diffusore smerigliato
in Policarbonato

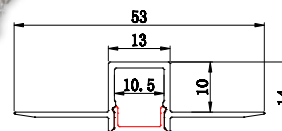

Kit composto da:
1xProfilo
1xDiffusore
2xTappi

IP 20 2 mt IMB 3

KIT PROFILI 400932

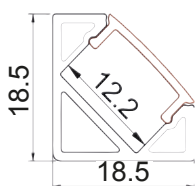

€ 22,248

Kit composto da:
1xProfilo
1xDiffusore
2xTappi
2xClips

IP 20 2 mt IMB 6

COVER

€ 50,161

401002 NEW
Cover smerigliata
bobina 10mt
per 400986



IP 20 IMB 1

€ 29,701

401004 NEW
Cover da lavoro
bobina 10mt
per 400986

IP 20 IMB 1

€ 9,375

400898
Cover smerigliata
da 2mt
per 400986



IP 20 IMB 25

KIT PROFILI 400933



Profilo da pavimento
clapestabile

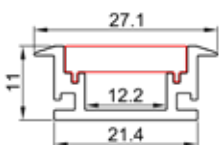

€ 37,208

Kit composto da:
1xProfilo
1xDiffusore
2xTappi

IP 20 2 mt IMB 20

KIT PROFILI 400949

€ 22,515



Profilo in alluminio
flessibile

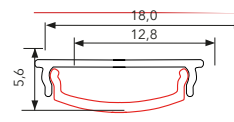

Kit composto da:
1xProfilo
1xDiffusore
3xTappi
4xClips

IP 20 2 mt IMB 1

KIT PROFILI 401000 NEW

Profilo con alette per cartongesso
Diffusore smerigliato
in Policarbonato

Luce XL

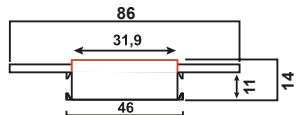

€ 66,000

Kit composto da:
1xProfilo
1xDiffusore
2xTappi

IP 20 **2 mt** IMB 3

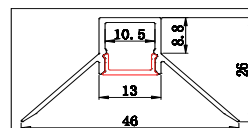
PROFILI 400895

€ 28,154

1xProfilo
400895
1xDiffusore
400898
2xTappi
400900

IP 20 **2 mt** IMB 3

COVER 401001 NEW

€ 105,601

Cover smerigliata
bobina 10mt
per 401000

IP 20 **10 mt** IMB 1

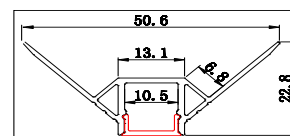
PROFILI 400896

€ 33,131

1xProfilo
400896
1xDiffusore
400898
2xTappi
400901

IP 20 **2 mt** IMB 3

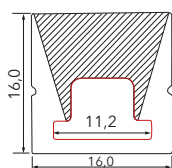
KIT PROFILI 400946

€ 61,601

1xProfilo silicone
1xDiffusore
400946
2xTappi
400947
2xClips
400948

IP 20 **2 mt** IMB 1

KIT PROFILI 400950

€ 76,299

Kit composto da:
1xProfilo
1xDiffusore
2xTappi

IP 20 **2 mt** IMB 1

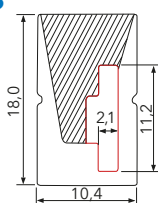
KIT PROFILI 400943

€ 50,345

1xProfilo silicone
1xDiffusore
400943
2xTappi
400944
2xClips
400945

IP 20 **2 mt** IMB 1

KIT PROFILI 400951

€ 80,051

Kit composto da:
1xProfilo
1xDiffusore
2xTappi

IP 20 **2 mt** IMB 1

PIATTINA 400897

€ 9,317

Piattina in
alluminio estruso
anodizzato

IP 20 **2 mt** IMB 10

www.poliplastsrl.com



COB - IP20 Led 504/mt
Dim. 10x5000

€ 95,000



- 400985W
- 400985D

Input 24Vcc Lm 1800
Cons. 14,4W/mt Led COB 504/mt

CRI >90 IP 20 IMB 50/1

14,4 W/mt - IP20 Led 70/mt
Dim. 10x5000

€ 34,550



- 400859W
- 400859C
- 400859D

Input 24Vcc Lm 1600
Cons. 14,4W/mt Led SMD2835 70/mt

CRI >80 IP 20 IMB 50/1

19,2 W/mt - IP20 Led 240/mt
Dim. 10x5000

€ 59,512



- 400979W
- 400979C
- 400979D

Input 24Vcc Lm 2800
Cons. 19,2W/mt Led SMD2835 240/mt

CRI >80 IP 20 IMB 50/1

14,4 W/mt - IP20 Led 192/mt
Dim. 10x5000

€ 50,663



- 400965W
- 400965C
- 400965D

Input 24Vcc Lm 2100
Cons. 14,4W/mt Led SMD2835 192/mt

CRI >80 IP 20 IMB 50/1

24 W/mt - IP20 Led 140/mt
Dim. 10x5000

€ 121,124



- 400924W
- 400924C
- 400924D

Input 24Vcc Lm 3050
Cons. 24W/mt Led SMD2835 140/mt

CRI >80 IP 20 IMB 50/1

14,4 W/mt - IP20 Led 240/mt
Dim. 8x5000

€ 54,102



- 400978W
- 400978C

Input 24Vcc Lm 2200
Cons. 14,4W/mt Led SMD2835 240/mt

CRI >80 IP 20 IMB 50/1

28.8 W/mt - IP20 Led 238/mt
Dim. 10x5000

€ 195,364



- 400925W
- 400925C
- 400925D

Input 24Vcc Lm 3300
Cons. 28,8W/mt Led SMD2835 238/mt

CRI >80 IP 20 IMB 50/1

14,4 W/mt - IP67 Led 128/mt
Dim. 10x5000

€ 72,057



- 400980W
- 400980C
- 400980D

Input 24Vcc Lm 1950
Cons. 14,4W/mt Led SMD2835 128/mt

CRI >80 IP 67 IMB 25/1

19,2 W/mt - IP67 Led 192/mt
Dim. 12x5000

€ 82,344



- 401012W
- 401012C
- 401012D

Input 24Vcc Lm 2400
Cons. 19,2W/mt Led SMD2835 192/mt

CRI >80 IP 67 IMB 25/1

STRISCE LED
RGB - 14,4 W/mt - IP20 Led 60/mt
 Dim. 10x5000

€ 82,136

 400864 **RGB**

 Input 24Vcc Lm RGB
 Cons. 14,4W/mt Led SMD5050 60/mt

CRI >80 **IP 20** **IMB 25/1**
RGB - 14,4 W/mt - IP55 Led 60/mt
 Dim. 10x5000

€ 141,784

 400884 **RGB**

 Input 24Vcc Lm RGB
 Cons. 14,4W/mt Led SMD5050 60/mt

CRI >80 **IP 55** **IMB 25/1**
DRIVER PER STRISCE LED
25W DRIVER
 Dim. 85x58x38

€ 17,650

IP 20 **IMB 72/1**

Input 100-240V~

400685 12V | 2,1A | 25W
400685-24 24V | 1,0A | 25W

36W DRIVER
 Dim. 85x58x38

€ 19,789

IP 20 **IMB 72/1**

Input 100-240V~

400888 12V | 3,0A | 36W
400888-24 24V | 1,5A | 36W

60W DRIVER **SLIM**
 Dim. 139x55x28

€ 20,466

IP 20 **IMB 70/1**

Input 100-240V~

400686 12V | 5,0A | 60W
400686-24 24V | 2,5A | 60W

100W DRIVER **SLIM**
 Dim. 139x55x28

€ 29,416

IP 20 **IMB 40/1**

Input 100-240V~

400687 12V | 8,3A | 100W
400687-24 24V | 4,16A | 100W

150W DRIVER **SLIM**
 Dim. 178x61x28

€ 35,818

IP 20 **IMB 60/1**

Input 100-240V~

400664 12V | 12,5A | 150W
400664-24 24V | 6,25A | 150W

250W DRIVER **SLIM**
 Dim. 215x61,7x30,8

€ 51,787

IP 20 **IMB 44/1**

Input 175-240V~

400696 12V | 20,0A | 250W
400696-24 24V | 10,0A | 250W

300W DRIVER **SLIM**
 Dim. 215x61,7x30,8

€ 64,130

IP 20 **IMB 44/1**

Input 175-240V~

400991 12V | 25,0A | 300W
400991-24 24V | 12,5A | 300W

15W DRIVER

Dim. 100x30x22



IP 40 | IMB 210/1

400992 12V | 1,0A | 15W
400992-24 24V | 0,5A | 15W

Input 100-240V~

€ 14,740

60W DRIVER

Dim. 185x40x30



IP 67 | IMB 72/1

400889 12V | 5,0A | 60W
400889-24 24V | 2,5A | 60W

Input 100-240V~

€ 45,883

35W DRIVER

Dim. 145x38x22



IP 40 | IMB 80/1

400993 12V | 3,0A | 35W
400993-24 24V | 1,5A | 35W

Input 100-240V~

€ 25,810

100W DRIVER

Dim. 172x70x40



IP 67 | IMB 72/1

400890 12V | 8,3A | 100W
400890-24 24V | 4,16A | 100W

Input 100-240V~

€ 77,937

50W DRIVER

Dim. 176x42x24



IP 40 | IMB 100/1

400994 12V | 4,0A | 50W
400994-24 24V | 2,0A | 50W

Input 100-240V~

€ 33,180

150W DRIVER

Dim. 208x60x33



IP 67 | IMB 35/1

400891 12V | 12,5A | 150W
400891-24 24V | 6,25A | 150W

Input 100-240V~

€ 89,816

RGB CONTROLLER

Dim. 8,3x6,4x2,3



IP 20 | IMB 1

400865 - 18A | 12/24 Vcc | 3 canali

Input 100-240V~

€ 57,472

AMPLIFICATORE RGB

Dim. 10,5x6,4x2,3



IP 20 | IMB 1

400866 - 12A | 12/24 Vcc | 3 canali

Input 100-240V~

€ 33,075

6W KIT EMERGENZA

Dim. 170x55x28



IP 20 | IMB 1

400793 100/150/200mA | 6W

Input 220-240V~

Tens. max 55V

€ 70,718

www.poliplastsrl.com

DRIVER PER STRISCIE LED

ACCESSORI

PLAFONIERE DA INTERNO
PLAFONIERE DA INTERNO
10W 800Lm

Dim. 300x75x25

GIORGIA
€ 16,480

- 400801W
- 400801C
- 400801D

IP 20 IMB 20/1

18W 1600Lm

Dim. 600x75x25

GIORGIA
€ 21,023

- 400802W
- 400802C
- 400802D

IP 20 IMB 20/1

30W 2400Lm

Dim. 900x75x25

GIORGIA
€ 27,001

- 400803W
- 400803C
- 400803D

IP 20 IMB 20/1

36W 4320Lm

Dim. 1200x75x25

GIORGIA
€ 32,300

- 400804W
- 400804C
- 400804D

IP 20 IMB 10/1

45W 5400Lm

Dim. 1500x75x25

GIORGIA
€ 51,000

- 400805W
- 400805C
- 400805D

IP 20 IMB 10/1

8W 920Lm

Dim. 584X22X30

TECNOLOGIA TRICOLOR
VERONICA
€ 23,365

400995CCT



IP 20 IMB 30/1

10W 1150Lm

Dim. 884X22X30

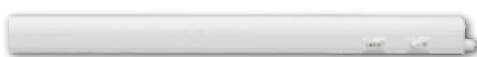
TECNOLOGIA TRICOLOR
VERONICA
€ 27,390

400996CCT



IP 20 IMB 30/1

14W 1610Lm

Dim. 1184X22X30

TECNOLOGIA TRICOLOR
VERONICA
€ 30,764

400997CCT



IP 20 IMB 30/1

18W 2070Lm

Dim. 1484X22X30

TECNOLOGIA TRICOLOR
VERONICA
€ 38,096

400998CCT



IP 20 IMB 30/1

CABLATA PER TUBI A LED

Dim. 660x69x78mm



OFELIA
€ **16,221**

400755-18LED

IP 65 IMB 10

CABLATA PER TUBI A LED

Dim. 660x99x78mm



OFELIA
€ **21,299**

400755-18-2LED

IP 65 IMB 10

CABLATA PER TUBI A LED

Dim. 1260x69x78



OFELIA
€ **22,154**

400755-36LED

IP 65 IMB 10

CABLATA PER TUBI A LED

Dim. 1260x99x78



OFELIA
€ **27,206**

400755-36-2LED

IP 65 IMB 10

CABLATA PER TUBI A LED

Dim. 1560x69x78



OFELIA
€ **28,295**

400755-58LED

IP 65 IMB 10

CABLATA PER TUBI A LED

Dim. 1560x99x78



OFELIA
€ **34,850**

400755-58-2LED

IP 65 IMB 10

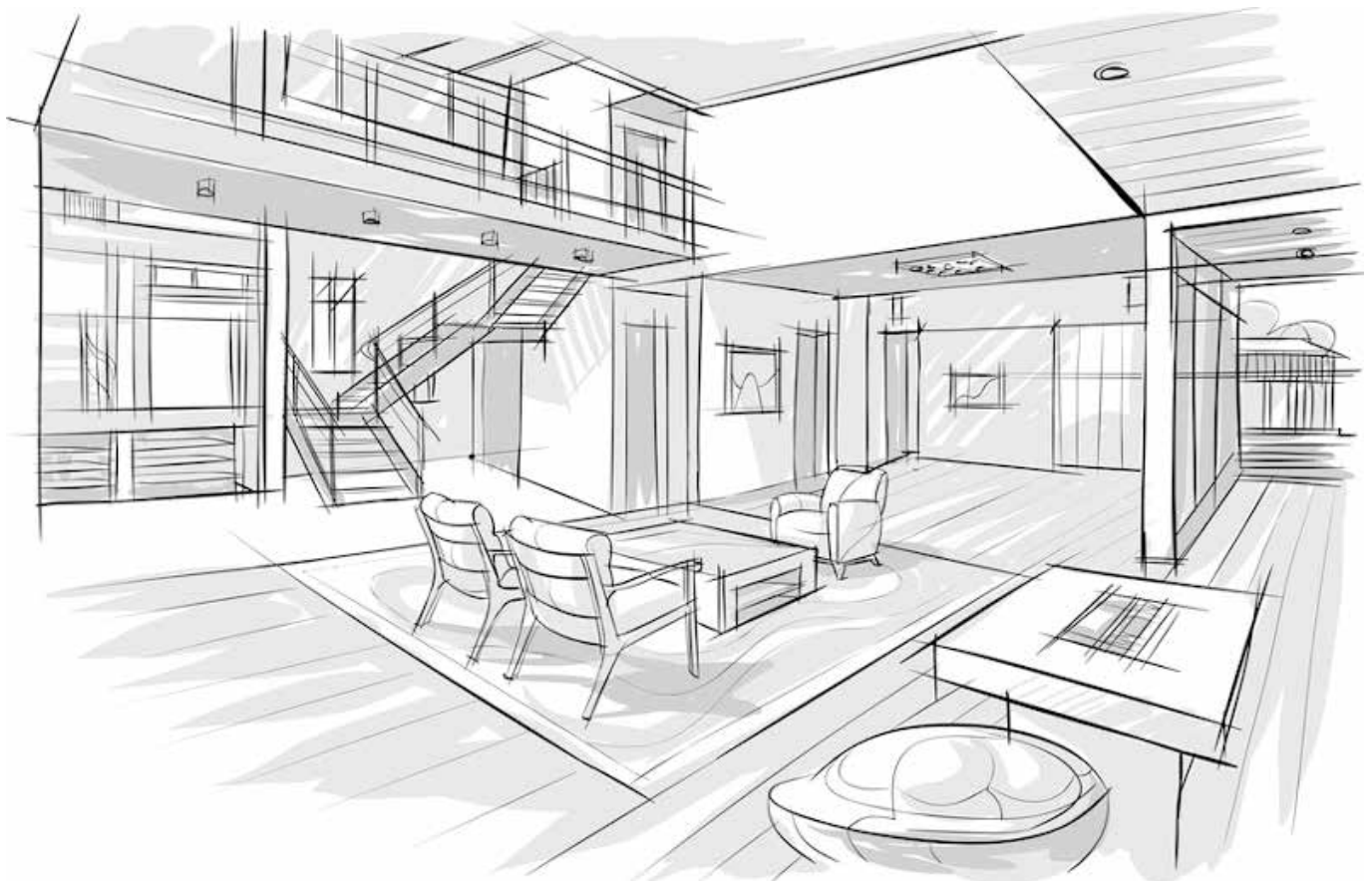

6W 780Lm
 Luce bidirezionale

NEW



Dim. 255x90x30

GILDA
€ 37,400

 401013

 Cover bianca
 inclusa

IP 65 IMB 20/1

4W 500Lm

NEW



Dim. 230x80x27

SOLEIL
€ 31,900

 401014

 Cover bianca
 inclusa

IP 65 IMB 20/1

8W 1000Lm
 Luce bidirezionale

NEW



Dim. 170x80x46

EMILY
€ 37,400

 401017C
 401017BC

IP 65 IMB 20/1

2W 220Lm

NEW

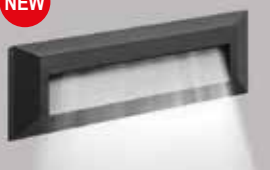

Dim. 230x80x27mm

PALMIRA
€ 34,158

 401026

 Cover bianca
 inclusa

IP 65 IMB 20/1

6W 780Lm

NEW



Dim. 255x90x30mm

TERESA
€ 42,232

 401027

 Cover bianca
 inclusa

IP 65 IMB 20/1

GU10

NEW



Dim. 152x92xØ69mm

BERTA
€ 22,954

401029 ●

IP 65 IMB 20/1

6W 650Lm
 Luce bidirezionale

NEW



Dim. 140x130x40

MARICLA
€ 34,101

 401015C ●
 401015BC ○

IP 65 IMB 20/1

6W 620Lm
 Luce bidirezionale

NEW



Dim. 170x120x48

MANOLA
€ 37,400

 401016C ●
 401016BC ○

IP 65 IMB 20/1

E27

NEW



Dim. 260x136x91

IRENE
€ 24,750

401019

IP 54 IMB 20/1

GU10

NEW



Dim. 800x251xØ150mm

NINA
€ 60,863

401030 ●

IP 65 IMB 6/1

E27

NEW



Dim. Ø160x1000

NORA
€ 57,750

401018

IP 54 IMB 4/1

2xGU10

NEW



Dim. 800x352xØ150mm

ZOE
€ 77,632

401031 ●

IP 65 IMB 6/1



GU10

NEW



FABIANA
€15,950

- 401020N ●
- 401020B ○

IP 44 IMB 20/1

Dim. 92x90x70

GU10

NEW



ADRIANA
€21,737

- 401032N ●
- 401032B ○

IP 65 IMB 24/1

Dim. 110x110x85mm

GU10

NEW



ALBA
€18,011

- 401034N ●
- 401034B ○

IP 54 IMB 20/1

Dim. 92x70x90mm

2xGU10

Luce bidirezionale

NEW



AURORA
€18,701

- 401021N ●
- 401021B ○

IP 44 IMB 20/1

Dim. 160x92x70

2xGU10

Luce bidirezionale

NEW



BERENICE
€29,189

- 401033N ●
- 401033B ○

IP 65 IMB 20/1

Dim. 110x85x195mm

2xGU10

Luce bidirezionale

NEW



LARA
€19,874

- 401035N ●
- 401035B ○

IP 54 IMB 20/1

Dim. 92x70x160mm

3xE27

NEW



LORETTA
€180,851

- 401028N ●
- 401028B ○

IP 44 IMB 1/1

Dim. 2216x578mm

6W
400Lm



IOLE
€19,473

Dim. 255xØ58

- 400936W ●
- 400936C ○
- 400936D ●

IP 65 IMB 25/1

FILTRI COLORATI

€ 2,540

Dim. Ø56



- 400937BL ●
- 400937G ●
- 400937R ●

IMB 10/1

E27 Lanterna in polipropilene

REVERSIBILE



Montato con braccio a sostegno
Dim. 260x195x420



Montato con braccio a sospensione
Dim. 270x231x400

MIRELLA
€ 26,769

- 400423B ○
- 400423N ●
- 400423OR ●

Vetri trasparenti IP 44 IMB 6/1

GU10

NEW



ALDA
€ 17,601

- 401022N ●
- 401022B ○

IP 44 IMB 20/1

Dim. 194x110xØ60

E27



NINFA
€ 37,645

- 400422B ○
- 400422N ●
- 400422OR ●

IP 44 IMB 6/1

Dim. 330x220x420

E27

NEW



AMANDA
€ 24,640

- 401024B ○
- 401024N ●
- 401024OR ●

IP 44 IMB 6/1

Dim. Ø222x386
Foro x palo Ø60

10W 800Lm

- 400869W
- 400869C
- 400869D
- 400869W-B
- 400869C-B
- 400869D-B



Dim. 95x69x23

IMB 40/1 IP 65

VICKY
€ 9,102

20W 1600Lm

- 400870W
- 400870C
- 400870D
- 400870W-B
- 400870C-B
- 400870D-B



Dim. 108x81x24

IMB 20/1 IP 65

VICKY
€ 14,999

30W 2550Lm

- 400871W
- 400871C
- 400871D
- 400871W-B
- 400871C-B
- 400871D-B



Dim. 143x108x24

IMB 10/1 IP 65

VICKY
€ 22,356

50W 4250Lm

- 400872W
- 400872C
- 400872D
- 400872W-B
- 400872C-B
- 400872D-B



Dim. 187x140x24

IMB 10/1 IP 65

VICKY
€ 28,549

100W 8500Lm

- 400893W
- 400893C
- 400893D
- 400893W-B
- 400893C-B
- 400893D-B



Dim. 274x197x28

IMB 5/1 IP 65

VICKY
€ 57,999

150W 13000Lm

- 400938C
- 400938D
- 400938C-B
- 400938D-B



Dim. 305x233x31

IMB 5/1 IP 65

VICKY
€116,020

200W 17000Lm

- 400939C
- 400939D
- 400939C-B
- 400939D-B



Dim. 358x277x33

IMB 3/1 IP 65

VICKY
€159,466

30W 2550Lm

- 400940C
- 400940D
- 400940C-B
- 400940D-B



Dim. 143x160x55

IMB 10/1 IP 65

VICKY
€ 34,666



50W NEW

☐ 401007C

Solar lamp



Dim. proiettore 205X202X53
Dim. pannello 290X210X21,5

IMB 2/1 IP 65

VICKY
€ 109,355

100W NEW

☐ 401008C

Solar lamp

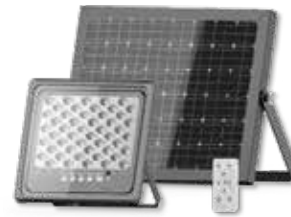

Dim. proiettore 233x235x53
Dim. pannello 370x285x21,5

IMB 2/1 IP 65

VICKY
€ 156,034

200W NEW

☐ 401009C

Solar lamp



Dim. proiettore 275x270x53
Dim. pannello 400x370x25

IMB 2/1 IP 65

VICKY
€ 203,977

300W NEW

☐ 401036C

Solar lamp



Dim. proiettore 323x315x53
Dim. pannello 500x370x30

IMB 2/1 IP 65

VICKY
€ 237,428



2xGU10

Luce bidirezionale



Dim. Ø65x160

FEBE

€ 53,218

400934B ○
400934G ●

IMB 10/1 IP 54

2x3W 162Lm

Luce bidirezionale



Dim. 91X98X93

MILA

€ 57,112

400935W ●
400935C ●
400935BW ○
400935BC ○

IMB 20/1 IP 54

E27



Dim. 250x110x103

MALENA

€ 57,199

401037B ○
401037N ●
401037AN ●
401037CO ●

Schermo policarbonato

IP 54 IMB 12/1

2x8W 2x560Lm

Luce bidirezionale



Dim. 220x69x45

ASSIA

€ 123,365

400960W ●
400960C ●
400960BW ○
400960BC ○

IMB 10/1 IP 54

7W 480Lm
CAROLA
€ 131,515

400778



Dim. Ø260x140x140

Corpo in alluminio anticorrosione

IP 54 IMB 4/1

7W 480Lm
CAROLA
€ 159,189

400779



Dim. Ø260x1000x140

Corpo in alluminio anticorrosione

IP 54 IMB 2/1

7W 480Lm
MARICA
€ 70,365

400780



Dim. 130x60x150

Corpo in alluminio anticorrosione

IP 54 IMB 12/1

7W 480Lm
MARICA
€ 101,908

400781



Dim. 150x1000x60

Corpo in alluminio anticorrosione

IP 54 IMB 6/1

E27
SILVIA
€ 47,191

400409N



Dim. Ø245x875

Schermo policarbonato

IP 33 IMB 8/1

E27
AGNESE
€ 24,521

Dim. 195x165x235

400981N



Schermo policarbonato

IP 33 IMB 6/1

E27
TESS
€ 25,019

 Dim. 165x165x235
 attacco palo Ø60

400989N



Schermo policarbonato

IP 33 IMB 6/1

E27
ELÈNA
€ 49,226

400408N



Dim. 475x395x245

Schermo policarbonato

IP 33 IMB 4/1

E27
ALICE
€ 24,521

Dim. 195x165x235

400982N



Schermo policarbonato

IP 33 IMB 6/1

E27
DORA
€ 56,803

 Dim. 165x165x955
 Tubo Ø40

400984N



Schermo policarbonato

IP 33 IMB 6/1

E27
CECILIA
€ 25,267

 Dim. 165x165x235
 +560 catena

400983N



Schermo policarbonato

IP 33 IMB 6/1

E27



GINEVRA
€ 29,730

Dim. 270x231x400

400400B ○
400400N ●

Vetri trasparenti

IP 33 IMB 6/1

E27



GINEVRA
€ 21,814

Dim. 220x200x340

400400B-60 ○
400400N-60 ●

Vetri trasparenti

IP 33 IMB 6/1

E27



ANNALISA
€ 81,574

Dim. 230x260x1200
Tubo Ø60

400402

Vetri trasparenti

IP 33 IMB 1

E27



VITTORIA
€ 29,730

Dim. 270x231x400

400401B ○
400401N ●

Vetri trasparenti

IP 33 IMB 6/1

E27



VITTORIA
€ 21,814

Dim. 220x200x340

400401B-60 ○
400401N-60 ●

Vetri trasparenti

IP 33 IMB 6/1

E27



GIADA
€ 28,101

Dim. Ø200x303x875

400438N

Vetri trasparenti

IP 33 IMB 6/1

E27



SERENA
€ 35,048

Dim. Ø230x458

400440N

Vetri trasparenti

IP 33 IMB 6/1

3xE27



SUSANNA
€ 275,628

Dim. 570x600x2280

400403

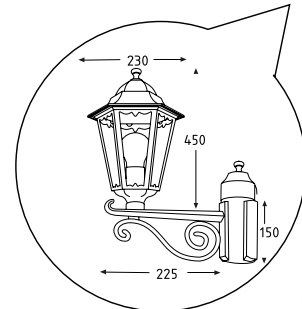

Vetri trasparenti

IP 33 IMB 1

E27



MARCELLA
€ 29,730

Dim. Ø230x393
Foro x palo Ø60

400414N

Vetri trasparenti

IP 33 IMB 6/1

E27



MARCELLA
€ 21,814

Dim. Ø200x333
Foro x palo Ø60

400414N-60

Vetri trasparenti

IP 33 IMB 6/1

E27



ENRICA
€ 81,574

Dim. 230x260x1200
Tubo Ø60

400406

Vetri sabbiati

IP 33 IMB 1

E27



ANASTASIA
€ 29,730

Dim. 270x231x400

400404B ○
400404N ●

Vetri sabbiati

IP 33 IMB 6/1

E27



ARIANNA
€ 29,730

Dim. 270x231x400

400405N

Vetri sabbiati

IP 33 IMB 6/1

E27



LORENA
€ 75,169

Dim. 250x275x450

400505

Schermo policarbonato

IP 44 IMB 4/1

E27



DIANA
€ 75,169

Dim. 250x275x450

400506

Schermo policarbonato

IP 44 IMB 4/1

E27



GLORIA
€ 75,169

Dim. 250x420
Ø60

400507

Schermo policarbonato

IP 44 IMB 4/1



E27



FLAVIA
€ 78,462

Dim. 248x310x480

400488

Schermo policarbonato

IP 44 IMB 4/1

E27



CINZIA
€ 78,462

Dim. 248x310x480

400475

Schermo policarbonato

IP 44 IMB 4/1

E27

NEW



ALFRIDA
€ 90,805

Dim. Ø250x460
Foro x palo Ø60

401006

Schermo policarbonato

IP 44 IMB 4/1

E27



LUIISA
€ 87,648

Dim. Ø248x538

400477

Schermo policarbonato

IP 44 IMB 4/1

E27



ELVIRA
€ 134,445

Dim. Ø248x1120

400478

Schermo policarbonato

IP 44 IMB 4/1

3xE27



ISOTTA
€ 468,292

Dim. 600x600x2230

400492

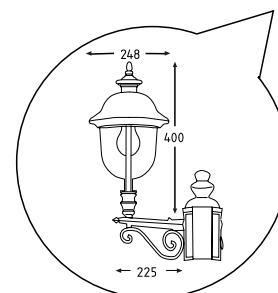

Schermo policarbonato

IP 44 IMB 1

E27



IMMA
€ 87,648

Dim. Ø248x1053

400476

Schermo policarbonato

IP 44 IMB 4/1

E27 **ADA**
€ 61,936
 Dim. 257x275x492
 400493
 Schermo policarbonato
 IP 44 IMB 4/1



E27 **SABRINA**
€ 61,936
 Dim. 248x538
 400495
 Schermo policarbonato
 IP 44 IMB 4/1

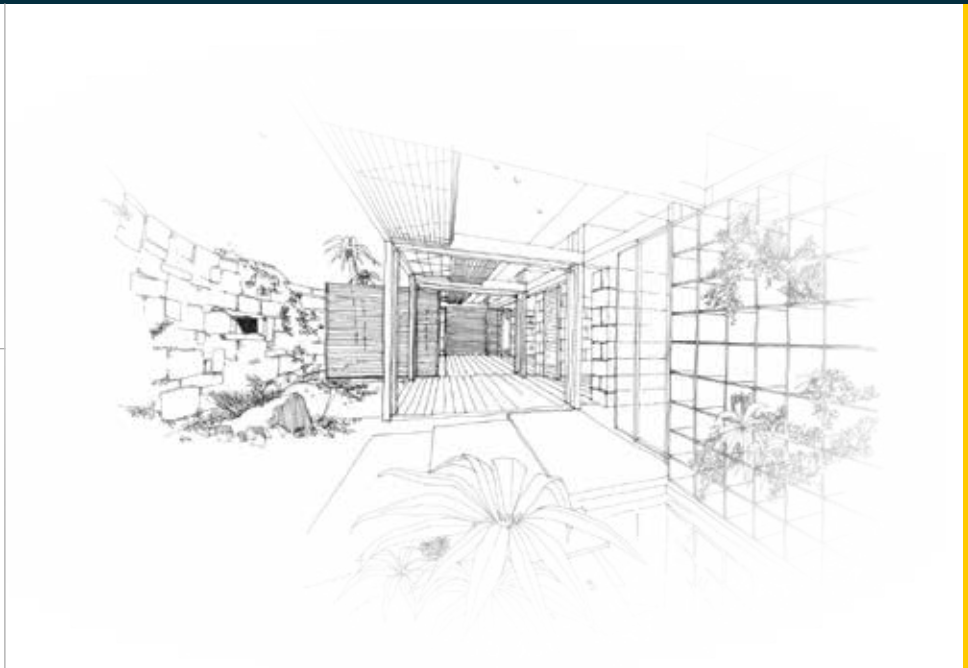

E27 **CLELIA**
€ 61,936
 Dim. 248x1053
 400496
 Schermo policarbonato
 IP 44 IMB 4/1

E27 **BELINDA**
€ 42,299
 Dim. 274x287x440
 400499
 Schermo acrilico opale
 IP 44 IMB 4/1



E27 **MATILDE**
€ 48,341
 Dim. 274x1053
 400502
 Schermo acrilico opale
 IP 44 IMB 4/1



E27 **ORietta**
€ 19,608
 Dim. 445xØ75
 400554
 IP 44 IMB 30/1



GU10 **NEW VANNA**
€ 30,361
 Dim. 102xØ65
 401005
 IP 65 IMB 30/1



GU10 **SIRENA1**
€ 29,669
 Dim. 95xØ98
 400431N-GU10
 IP 65 IMB 30/1



PALETTO
€ 3,735
 Dim. 170xØ45
 400451
 IMB 1



INCASSO A SUOLO

3W 200Lm



APRIL
€ 61,663

400873D



Dim. Ø100x108



18W 1450Lm



APRIL
€ 179,866

400876C
400876D

Dim. Ø210x120



INCASSO A SUOLO

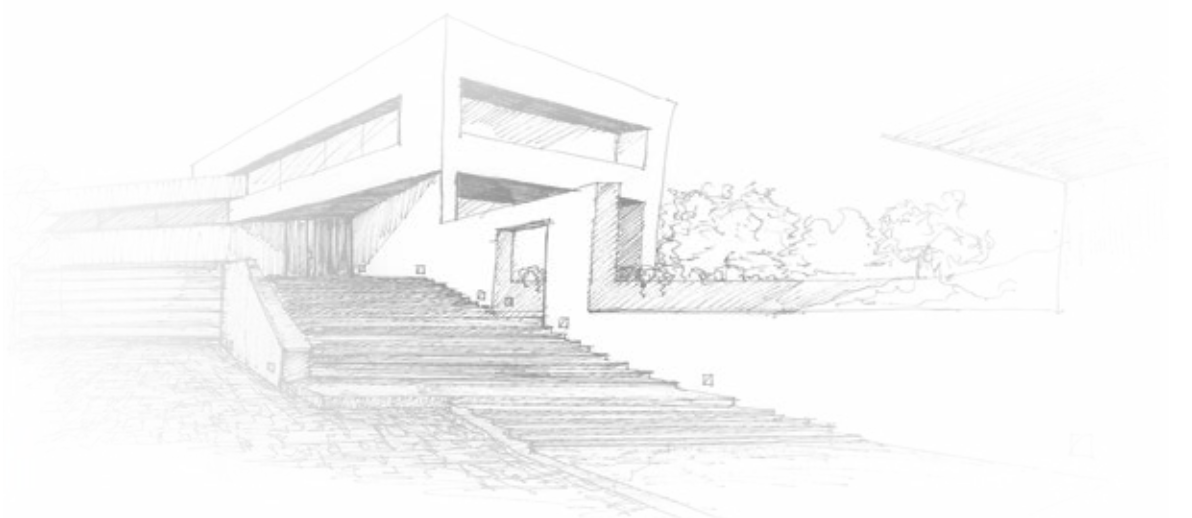

GU10



ADELE
€ 27,400

400877

GU10



ADELE
€ 32,493

400878

Dim. Ø100x120



Dim. 100x100X120



1W 95Lm

Dim. 30X30X30



Disponibile anche in BIANCO

EGLE € 19,680

- 400907AL-W
- 400907AL-C
- 400907AL-D
- 400907BI-W
- 400907BI-C
- 400907BI-D

220-240 ~ IP 20 IMB 100/1

0,2W 6Lm

Dim. 32XØ15



CIELO STELLATO

Disponibile anche in BIANCO

ALMA € 8,385

- 400908AL-W
- 400908AL-C
- 400908AL-D
- 400908BI-W
- 400908BI-C
- 400908BI-D

12V DC IP 67 IMB 200/1

1W 95Lm

Dim. 30XØ30



Disponibile anche in ALLUMINIO

EGLE € 19,680

- 400963AL-W
- 400963AL-C
- 400963AL-D
- 400963BI-W
- 400963BI-C
- 400963BI-D

220-240 ~ IP 20 IMB 100/1

0,5W 30Lm

Dim. 35XØ25



DANA € 35,399

- 400962W
- 400962C
- 400962D

12V DC IP 65 IMB 100/1



INCASSO PARETE

3W 250Lm

Dim. 90X70X70



Disponibile anche in BIANCO

FEDORA € 45,565

- 400789AL-W
- 400789AL-C
- 400789AL-D
- 400789BI-W
- 400789BI-C
- 400789BI-D

220-240 ~ IP 54 IMB 40/1

3W 250Lm

Dim. 90XØ70



Disponibile anche in ALLUMINIO

BICE € 45,565

- 400790AL-W
- 400790AL-C
- 400790AL-D
- 400790BI-W
- 400790BI-C
- 400790BI-D

220-240 ~ IP 54 IMB 40/1

INCASSO PARETE

3W 175Lm

Dim. 65X40X40



Disponibile anche in BIANCO

SVEVA
€ 41,778

- 400791AL-W
- 400791AL-C
- 400791AL-D
- 400791BI-W
- 400791BI-C
- 400791BI-D



3W 195Lm

Dim. 70XØ40



Disponibile anche in BIANCO

INES
€ 41,778

- 400792AL-W
- 400792AL-C
- 400792AL-D
- 400792BI-W
- 400792BI-C
- 400792BI-D



1,8W 80Lm

Dim. 65X40X40



Disponibile anche in ALLUMINIO

SVEVA
€ 41,778

- 400791AL-RGB
- 400791BI-RGB



1,8W 80Lm

Dim. 70XØ40



Disponibile anche in ALLUMINIO

INES
€ 41,778

- 400792AL-RGB
- 400792BI-RGB



8W 800Lm

Dim. 102x87X234



Pozzetto compreso

MALIN
€ 41,809

- 400902W
- 400902C
- 400902D



E27

Dim. 100x80X235



DEBORA
€ 23,554

- 400435N
- 400435G
- 400435B



SEGNAPASSO

POZZETTO
€ 5,083

400454



Dim. 100x80X235
Pozzetto per art. 400435



Cornici per art. 400902 - 400935

MALIN
€ 17,003

- 400903G 400904N
- 400903B 400904G
- 400904B
- 400905N
- 400905G
- 400905B



3W 170Lm

PUNTO LUCE ADATTO
PER POZZETTO
A 3 POSTI

CON 2 CORNICI

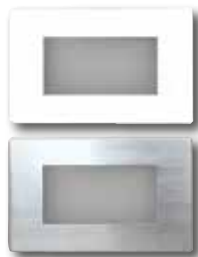

AMALIA
€ 23,895

- 400909W
- 400909C
- 400909D

Dim. 105X65X25



3W 170Lm

PUNTO LUCE ADATTO
PER POZZETTO
A 3 POSTI

CON 2 CORNICI



AMALIA
€ 25,393

400909CCT

TECNOLOGIA
TRICOLOR

Dim. 105X65X25



www.poliplastsrl.com



SEGNAPASSO

3W 250Lm

PUNTO LUCE ADATTO
PER POZZETTO A 3
POSTI

CORNICE IN VETRO



ELENA
€ 25,769

- 400999W
- 400999C
- 400999D

Dim. 107X67X51



3W 230Lm

PUNTO LUCE ADATTO
PER POZZETTO A 3
POSTI

CORNICE IN VETRO



ELENA
€ 28,124

400999CCT

TECNOLOGIA
TRICOLOR

Dim. 107X67X51

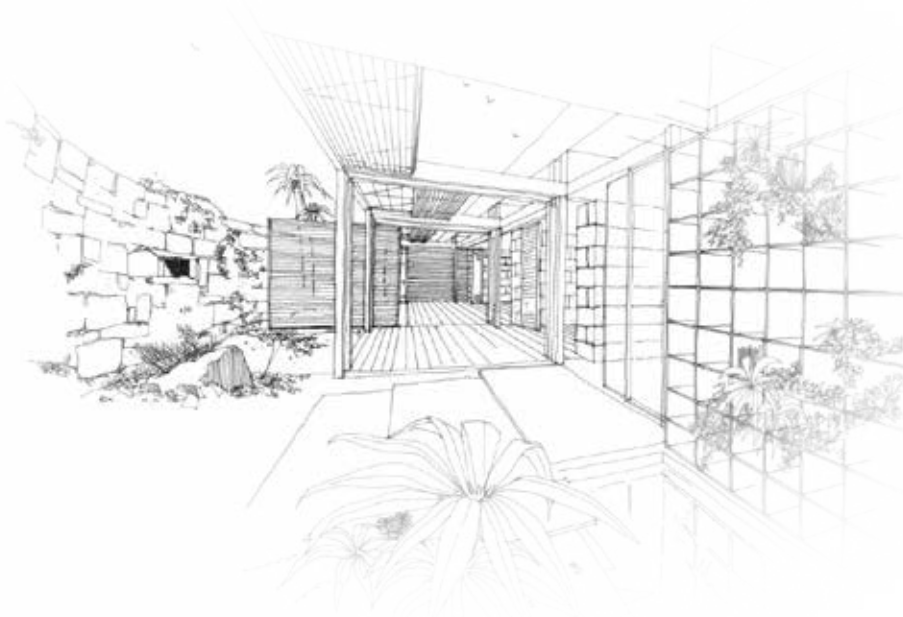

LED STYLE
LED STYLE
20W

 500785W
500785C
500785D

Dim. Ø65x135

GOCCIA
€ 6,550
Lumen
2300

Attacco
E27

 250° IMB
25

15W

 500767W
500767C
500767D

Dim. Ø60x123

GOCCIA
€ 4,050
Lumen
1500

Attacco
E27

 250° IMB
25

22W

 500788W
500788C
500788D

Dim. Ø120x159

GLOBO
€ 12,800
Lumen
2300

Attacco
E27

 240° IMB
10

12W

 500769W
500769C
500769D

Dim. Ø60x110

GOCCIA
€ 2,330
Lumen
1160

Attacco
E27

 250° IMB
25

9W

 500768W
500768C
500768D

Dim. Ø60x110

GOCCIA
€ 2,050
Lumen
820

Attacco
E27

 250° IMB
25

20W

 500784W
500784C
500784D

Dim. Ø125x170

GLOBO
€ 11,550
Lumen
2000

Attacco
E27

 210° IMB
10

8W

 500789W
500789C
500789D

Dim. Ø45x78

SFERA
€ 2,820
Lumen
806

Attacco
E14

 250° IMB
25

6W

 500770W
500770C
500770D

Dim. Ø45x78

SFERA
€ 1,990
Lumen
510

Attacco
E14

 250° IMB
25

8W

 500790W
500790C
500790D

Dim. Ø45x76

SFERA
€ 2,820
Lumen
806

Attacco
E27

 250° IMB
25

6W

 500771W
500771C
500771D

Dim. Ø45x76

SFERA
€ 1,990
Lumen
510

Attacco
E27

 250° IMB
25

8W

 500791W
500791C
500791D

Dim. Ø37X110

CANDELA
€ 2,820
Lumen
806

Attacco
E14

 250° IMB
25

6W

 500772W
500772C
500772D

Dim. Ø37X100

CANDELA
€ 1,990
Lumen
510

Attacco
E14

 250° IMB
25

6W

 500773W
500773C
500773D

Dim. Ø37X117

WIND
€ 1,990
Lumen
510

Attacco
E14

 250° IMB
25

12W

 500748W
500748C

Dim. Ø80X116

SPOT R80
€ 14,776
Lumen
1050

Attacco
E27

 120° IMB
10

8W

 500747W
500747C

Dim. Ø63X97

SPOT R63
€ 9,750
Lumen
670

Attacco
E27

 120° IMB
10

5W

 500746W
500746C

Dim. Ø50X86

SPOT R50
€ 5,960
Lumen
470

Attacco
E14

 110° IMB
10

10W

500795W
500795C
500795D



Dim. Ø37X121

TUBOLARE
€ 4,002

Lumen
1000
Attacco
E27
250° IMB
20

10W

500796W
500796C
500796D



Dim. Ø37X121

TUBOLARE
€ 4,002

Lumen
1000
Attacco
E14
250° IMB
20

11W

500797W
500797C
500797D



Dim. Ø42X110

TUBOLARE
€ 4,814

Lumen
1100
Attacco
E27
250° IMB
20

11W

500798W
500798C
500798D



Dim. Ø42X110

TUBOLARE
€ 4,814

Lumen
1100
Attacco
E14
250° IMB
20

2W

SPOT G4
€ 4,558

500779W
500779C
500779D



12V
DC
Lumen
150
Attacco
G4
Dim.
Ø24X33
140° IMB
25

2,5W

SPOT G4
€ 7,658

500780W
500780C
500780D



12V
AC/DC
Lumen
180
Attacco
G4
Dim.
Ø16X41
360° IMB
25

1,8W

SPOT G4
€ 5,415

500781W
500781C
500781D



12V
AC/DC
Lumen
180
Attacco
G4
Dim.
Ø9,5X37
360° IMB
25

3,3W

SPOT G9
€ 6,435

500782W
500782C
500782D



Lumen
330
Attacco
G9
Dim.
Ø16X49
360° IMB
25

2W

SPOT G9
€ 5,103

500786W
500786C
500786D



Lumen
200
Attacco
G9
Dim.
Ø14X40
360° IMB
25

1,7W

PERA E14
€ 4,664

500783W
500783C
500783D



Lumen
100
Attacco
E14
Dim.
Ø22,5X51
360° IMB
25



10W

500794W
Trasparente
500794C
Trasparente



**GOCCIA
a filamento**
€ 6,500

Lumen
1500

Attacco
E27

360° IMB
25

Dim. Ø70X135

8W

500793W
Trasparente
500793C
Trasparente



**GOCCIA
a filamento**
€ 3,950

Lumen
1055

Attacco
E27

360° IMB
25

Dim. Ø60X107

5W

500761W
Trasparente
500761C
Trasparente
500761B
Opale
500761F
Smerigliato



**SFERA
a filamento**
€ 3,250

Lumen
550

Attacco
E14

360° IMB
25

Dim. Ø45X77

5W

500724W
Trasparente
500724C
Trasparente
500724B
Opale
500724F
Smerigliato



**CANDELA
a filamento**
€ 3,250

Lumen
550

Attacco
E14

360° IMB
25

Dim. Ø35X97

5W

500725W
Trasparente
500725C
Trasparente
500725B
Opale
500725F
Smerigliato



**WIND
a filamento**
€ 3,250

Lumen
550

Attacco
E14

360° IMB
25

Dim. Ø35X120

5W

500764W
Trasparente
500764C
Trasparente



**TORTIGLIONE
a filamento**
€ 3,250

Lumen
550

Attacco
E14

360° IMB
25

Dim. Ø35X97

8W

500787
Trasparente



**GLOBO
a filamento**
€ 12,500

Lumen
1055

Attacco
E27

360° IMB
10

Dim. Ø125X175

7,5W

500766
Trasparente
500766B
Opale
500766F
Smerigliato



**GLOBO
a filamento**
€ 7,500

Lumen
806

Attacco
E27

360° IMB
20

Dim. Ø95X138

| | | | | | |
|------------|---|---|------------------------------|-----------------|------------------|
| 9W | TUBO LED T8 IN VETRO Ø28x602 | 500738W 500738C 500738D | Lumen 900 Attacco G13/T8 | € 5,800 | IMB 15 |
| 18W | TUBO LED T8 IN VETRO Ø28x1212 | 500739W 500739C 500739D | Lumen 2000 Attacco G13/T8 | € 8,800 | 220° PF >0,90 |
| 24W | TUBO LED T8 IN VETRO Ø28x1512 | 500740W 500740C 500740D | Lumen 2640 Attacco G13/T8 | € 11,000 | |
| 9W | TUBO LED T8 IN VETRO Ø28x602 | 500738W-ECO 500738C-ECO 500738D-ECO | Lumen 900 Attacco G13/T8 | € 5,100 | IMB 15 |
| 18W | TUBO LED T8 IN VETRO Ø28x1212 | 500739W-ECO 500739C-ECO 500739D-ECO | Lumen 2000 Attacco G13/T8 | € 6,650 | 220° PF >0,50 |
| 24W | TUBO LED T8 IN VETRO Ø28x1512 | 500740C-ECO 500740D-ECO | Lumen 2640 Attacco G13/T8 | € 9,050 | |

LED TUBI

| | | | | | |
|--|------------------------------------|---|--|------------------------------------|---|
| 7W 500778W 500778C 500778D | SPOT GU10 € 3,528 | Lumen 556 Attacco GU10 40° IMB 25 | 6W 500799W 500799C 500799D | SPOT GU10 € 2,880 | Lumen 530 Attacco GU10 100° IMB 50/10 |
|--|------------------------------------|---|--|------------------------------------|---|

| | | | | | |
|--|------------------------------------|---|--|--|--|
| 7W 500720W 500720C 500720D | SPOT GU10 € 3,528 | Lumen 600 Attacco GU10 60° IMB 25 | | | |
|--|------------------------------------|---|--|--|--|

LED SPOT

www.poliplastsrl.com

SPINE-PRESE
PRESE E ADATTATORI

 Uscita assiale
2P+T - 10A 250V~

Spina dritta
€ 0,867

 300600B ○
300600N ●

 IMB
300/50

 Uscita assiale
2P+T - 16A 250V~

Spina dritta
€ 1,135

 300601B ○
300601N ●

 IMB
300/50

 Uscita assiale
2P+T - 10A 250V~

Spina 90°
€ 0,979

300602B ○

 IMB
300/50

 Uscita assiale
2P+T - 16A 250V~

Spina 90°
€ 1,135

300603B ○

 IMB
300/50

 Uscita assiale
2P+T - 10A 250V~

Spina 90°
€ 1,235

 300621B ○
300621N ●

 IMB
300/50

 Uscita assiale
2P+T - 16A 250V~

Spina 90°
€ 1,417

 300622B ○
300622N ●

 IMB
300/50

 Uscita assiale
2P+T - 16A 250V~

Schuko 90°
€ 1,705

300618B ○

 IMB
300/25

 Uscita assiale
2P+T - 16A 250V~

Schuko dritta
€ 1,490

300619B ○

 IMB
300/25

 Presa Schuko
2P+T - 10/16A 250V~

Schuko bivalente
€ 1,428

 300620B ○
300620N ●

 IMB
300/25

 Presa
2P+T - 10A 250V~

Presa
€ 1,222

 300604B ○
300604N ●

 IMB
300/50

 Presa
2P+T - 10/16A 250V~

Presa bivalente
€ 1,465

 300605B ○
300605N ●

 IMB
200/25

 Spina 2P+T 16A
presa 2P+T 10/16A 250V~

Adattatore
€ 1,647

 300607B ○
300607N ●

 IMB
300/25

 Spina schuko 2P+T 16A
presa 2P+T 10/16A 250V~

Adattatore
€ 1,804

300616B ○

 IMB
200/50

 Spina 2P+T 10A
Presse Schuko 2P+T 250V~

Adattatore
€ 1,641

 300610B ○
300610N ●

 IMB
300/50

 Spina 2P+T 16A
presa schuko 2P+T 250V~

Adattatore
€ 1,759

 300611B ○
300611N ●

 IMB
300/50

 Spina 2P+T 10A
3 prese 2P+T 10A 250V~

Adattatore
€ 1,859

 300617B ○
300617N ●

 IMB
200/50

 Spina 2P+T 16A
Presse 2P+T 10/16A 250V~

Adattatore
€ 1,897

 300609B ○
300609N ●

 IMB
400/50

 Spina 2P+T 16A
presa schuko +
2 prese 2P+T 10/16A 250V~

Adattatore
€ 2,682

 300613B ○
300613N ●

 IMB
200/50

Spina 2P+T 16A
3 prese, 2P+T 10/16A



Presa Multipla

€ 5,608

200603 ○



Spina 2P+T 16A
4 prese, 2P+T 10/16A



Presa Multipla

€ 6,090

200604 ○



Spina 2P+T 16A
5 prese, 2P+T 10/16A



Presa Multipla

€ 6,625

200605 ○



Spina 2P+T 16A
3 schuko 2P+T 10/16A



Presa Mult. Schuko

€ 8,625

200613 ○

NEW



Spina 2P+T 16A
4 schuko 2P+T 10/16A



Presa Mult. Schuko

€ 9,779

200614 ○

200614N ●



Spina 2P+T 16A
5 schuko 2P+T 10/16A



Presa Mult. Schuko

€ 10,928

200615 ○

200615N ●



Spina 2P+T 16A
6 schuko 2P+T 10/16A



Presa Mult. Schuko

€ 11,924

200616 ○

200616N ●



Spina 2P+T 16A
7 schuko 2P+T 10/16A



Presa Mult. Schuko

€ 13,166

200617 ○

200617N ●



Spina 2P+T 16A
4 schuko 2P+T 10/16A



Presa Mult. Schuko

€ 11,316

200624N ●

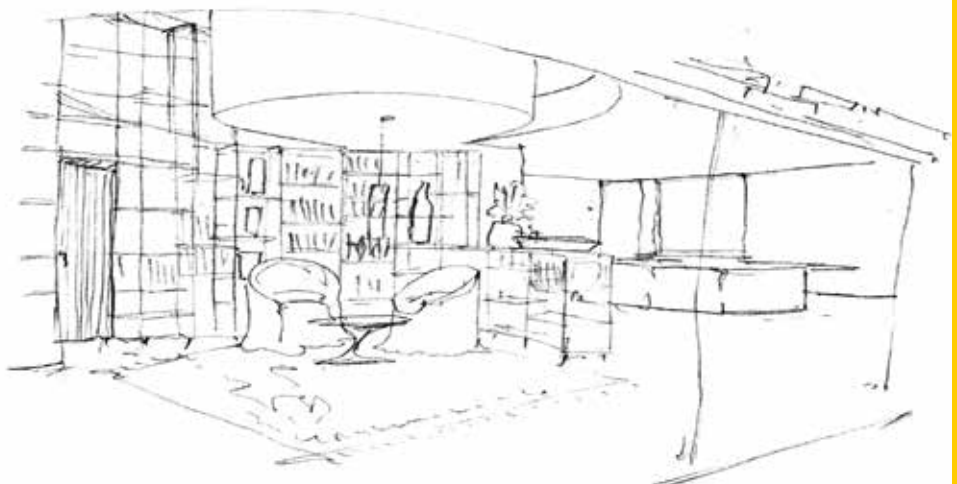

www.poliplastsrl.com



PRESE MULTIPLE

PRESE MULTIPLE

Cavo H05VV-F 3x0,75
Spina 2P+T 10A
Presca 2P+T 10A 250V~
Lungh. 2 mt

Prolunga 10A

€ 5,208

100112B ○
100112N ●



IMB
50/10

Cavo H05VV-F 3x0,75
Spina 2P+T 10A
Presca 2P+T 10A 250V~
Lungh. 3 mt

Prolunga 10A

€ 6,558

100103B ○
100103N ●



IMB
50/10

Cavo H05VV-F 3x0,75
Spina 2P+T 10A
Presca 2P+T 10A 250V~
Lungh. 5 mt

Prolunga 10A

€ 9,525

100105B ○
100105N ●



IMB
30/10

Cavo H05VV-F 3x1,00
Spina 2P+T 16A
Presca 2P+T 10/16A 250V~
Lungh. 3 mt

Prolunga 16A

€ 9,096

100203B ○
100203N ●



IMB
50/10

Cavo H05VV-F 3x1,00
Spina 2P+T 16A
Presca 2P+T 10/16A 250V~
Lungh. 5 mt

Prolunga 16A

€ 11,041

100205B ○
100205N ●



IMB
30/10

Spina 2P+T 10A 250V~
Lungh. 1,5 mt

Interr. passante

€ 4,468

100101B ○
100101N ●



IMB
100/10

Spina 2P+T 10A 250V~
Lungh. 3 mt

Telato 10A

€ 8,593

100100



IMB
25

GU10

Portalampanada

€ 1,007

600120



IMB
500/50

Lungh. 2 mt

Prolunga TV

€ 2,277

100302 ○
100302N ●



IMB
200/25

Lungh. 3 mt

Prolunga TV

€ 2,599

100303 ○
100303N ●



IMB
150/25

Lungh. 5 mt

Prolunga TV

€ 3,378

100305 ○
100305N ●



IMB
100/25



| Codice | Colore | Descrizione | Imballo | € - Euro |
|--------|--------|----------------|---------|----------|
| 4BI | Bianco | Graffetta 4mm | 1000 | 0,0220 € |
| 4GR | Grigio | Graffetta 4mm | 1000 | 0,0220 € |
| 5BI | Bianco | Graffetta 5mm | 1000 | 0,0230 € |
| 5GR | Grigio | Graffetta 5mm | 1000 | 0,0230 € |
| 6BI | Bianco | Graffetta 6mm | 1000 | 0,0280 € |
| 6GR | Grigio | Graffetta 6mm | 1000 | 0,0280 € |
| 7BI | Bianco | Graffetta 7mm | 1000 | 0,0300 € |
| 7GR | Grigio | Graffetta 7mm | 1000 | 0,0300 € |
| 8BI | Bianco | Graffetta 8mm | 1000 | 0,0370 € |
| 8GR | Grigio | Graffetta 8mm | 1000 | 0,0370 € |
| 10BI | Bianco | Graffetta 10mm | 1000 | 0,0510 € |
| 10GR | Grigio | Graffetta 10mm | 1000 | 0,0510 € |

Pacchi da 100pz.

Connettore F
Ø5,00

€ 0,269

210245



IMB
5000/100

Connettore F
Ø6,75

€ 0,269

210247



IMB
5000/100

Derivatore TV
1 presa 2 spine

€ 2,423

900202



IMB
1000/50

Spina coassiale
75 Ohm Ø9,5

€ 0,430

900203IT



IMB
2000/100

Adatt. TV
presa/presa Ø9,5

€ 0,807

900204



IMB
5000/100

Connettore F
doppio femmina

€ 0,807

900206



IMB
2000/100

Presa coassiale
75 Ohm Ø9,5

€ 0,429

900207



IMB
2000/100

Derivatore TV
2 prese 1 spina

€ 2,423

900208



IMB
1000/50

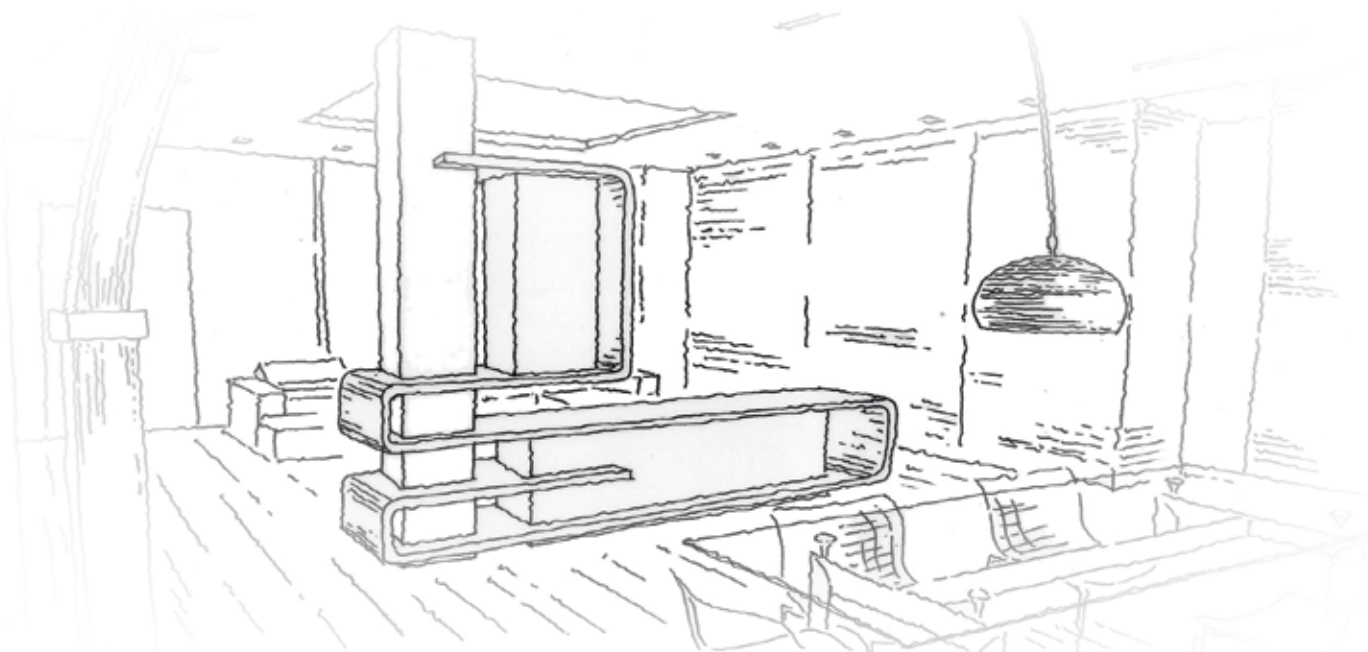

**Cavo coassiale
75 Ohm 2x0,50mm**
€ 1,225

EVO280

 IMB
500mt/100mt

**Cavo coassiale
75 Ohm ø3,70**
€ 0,262

EVO390

 IMB
500mt/100mt

**Cavo coassiale
75 Ohm ø5,00**
€ 0,270

EVO523

 IMB
750mt/150mt

**Cavo coassiale
75 Ohm ø6,65**
€ 0,274

EVO669

 IMB
500mt/100mt

**Cavo coassiale
75 Ohm ø5,00**
**CLASSE
A+**
€ 0,355

H805A

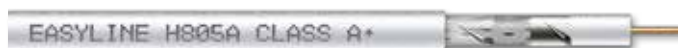
 IMB
250mt

**Cavo coassiale
75 Ohm ø6,70**
**CLASSE
A+**
€ 0,415

H807A

 IMB
200mt

ILLU EXPO

ESPOSITORE COMPONIBILE
IN DIVERSE CONFIGURAZIONI

€ 84,800

illuexpo



**Un unico
espositore per
tre diverse
configurazioni**

L'espositore è predisposto per accogliere diverse tipologie di confezioni, cambiando solamente la disposizione delle mensole in dotazione a seconda dell'ingombro del prodotto.

Ingombro totale:
L 64cm x P 41cm x
H 176cm

CORPORATE PANNELLI ESPOSITIVI

A-02



A-04



A-05

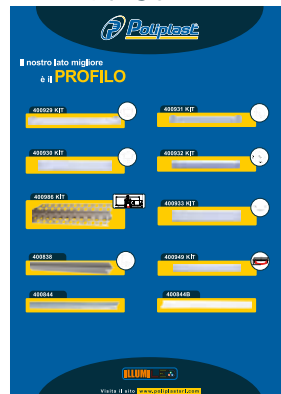

A-06



A-07



A-08



Espositori 100x70cm

spessore 10 mm (ingombro massimo con lampade 100x70x33)

I moduli sono realizzati in forex e sono predisposti per essere fissati a parete.

I prodotti esposti sono funzionanti e cablati.

A-09



A-10



A-11



A-12



A-13



A-14



A-17



CONDIZIONI GENERALI DI VENDITA

Il rapporto contrattuale conseguente al perfezionamento di ogni singolo ordine è retto dalle norme contenute nelle presenti condizioni generali di vendita. La parte acquirente rinuncia ad eventuali proprie condizioni generali di acquisto, salvo patto contrario specificatamente accettato per iscritto da POLIPLAST SRL.

L'ordine di acquisto si intende perfezionato ed è irrevocabile per la parte acquirente quando la stessa parte acquirente riceve formale conferma da parte di POLIPLAST. Una volta confermato, l'ordine di acquisto non può essere annullato senza il preventivo consenso scritto di POLIPLAST. In questa eventualità è riconosciuta a POLIPLAST la facoltà di richiedere un congruo indennizzo per le spese e per gli oneri sostenuti in ragione dell'iniziata esecuzione dell'ordine.

I prezzi indicati nei cataloghi/listini di vendita hanno un carattere meramente indicativo e potranno subire variazioni nel corso della validità dei cataloghi/listini stessi in ragione dell'aumento dei costi di produzione.

Una volta confermati con le modalità stabilite dall'art. 2, i prezzi di vendita previsti nell'ordine diventeranno vincolanti, fatto salvo, in ogni caso, il verificarsi di aumenti dei costi di produzione imprevedibili e indipendenti dalla volontà di POLIPLAST. In questa eventualità POLIPLAST provvederà a comunicare gli aumenti dei prezzi alla parte acquirente indicandone le cause.

I termini di consegna, salvo esplicito patto contrario, hanno un carattere solamente indicativo. Nel caso in cui l'esecuzione dell'ordine fosse impedita dal verificarsi di circostanze di forza maggiore, dalla mancata regolarità dei rifornimenti di materie prima o da altre circostanze imprevedibili sopravvenute, i termini di consegna si intenderanno prorogati e i nuovi termini verranno stabiliti di comune accordo tra le parti. La consegna dei prodotti alla parte acquirente avverrà EXW stabilimenti POLIPLAST SRL Catania (Italia). Il costo dell'imballaggio dei prodotti è a carico della parte acquirente e verrà fatturato al prezzo di costo.

La parte acquirente si impegna a verificare la conformità quantitativa e l'integrità dei colli inviati in contraddittorio con il vettore o con lo spedizioniere. Eventuali reclami per differenze quantitative o per colli danneggiati dovranno essere comunicati entro 8 giorni dal ricevimento della merce. Non sono ammesse restituzioni di prodotti se non preventivamente concordate e definite con POLIPLAST. Nei casi di resi autorizzati, i prodotti, dovranno essere restituiti in porto franco e imballo gratuito. In ogni caso non saranno prese in considerazione richieste di reso per articoli non presenti a listino in vigore al momento della richiesta.

La garanzia sui prodotti garantita al consumatore finale deve intendersi come garanzia convenzionale ai sensi dell'articolo 133 del Decreto Legislativo 6 settembre 2005, n. 206 (Codice del consumo). Il consumatore potrà pertanto far valere tali diritti nei confronti del venditore, alle condizioni e nei termini previsti dalla citata normativa e dalla presente garanzia convenzionale.

I prodotti sono garantiti per un periodo di due anni dalla data di acquisto. Le parti e i componenti dei prodotti soggette al deterioramento a causa dell'uso quali, a titolo puramente esemplificativo e non esaustivo, le batterie, ecc. sono garantiti per un periodo di un anno dalla data di acquisto.

Il Consumatore finale deve denunciare per iscritto il difetto di conformità al venditore entro il termine di due mesi dalla data della scoperta, a pena di decadenza.

In caso di difetto di conformità dei prodotti venduti, il consumatore potrà richiedere la riparazione o sostituzione dello stesso.

Qualora il rimedio richiesto dovesse risultare, ai sensi dell'art. 146 del Codice del Consumo, oggettivamente impossibile o eccessivamente oneroso, POLIPLAST provvederà al ripristino della conformità con rimedi alternativi.

In ogni caso, di difetti di conformità di lieve entità per il quale risulta essere oggettivamente impossibile o eccessivamente oneroso per POLIPLAST esperire i rimedi sopra previsti, non darà al consumatore finale il diritto di risolvere il contratto di vendita.

POLIPLAST garantisce la riparazione o sostituzione gratuita del bene non conforme. Spetta al consumatore, attraverso un documento di consegna rilasciato dal venditore o da altro documento probante (ricevuta fiscale, scontrino di cassa o similari, codice prodotto, ordini, contratti, ecc.), che riporti il nominativo del venditore e la data in cui è stata effettuata la vendita, dimostrare che la presente garanzia deve intendersi ancora valida.

La garanzia di cui al presente articolo non opera in tutti i casi di uso improprio del bene e, in particolare, in caso di uso dello stesso nell'ambito di attività commerciali, imprenditoriali o professionali, per le quali rimangono valide le norme di cui all'articolo 1490 e ss. c.c.

Non vengono inoltre coperte dalla garanzia le non conformità dovute a negligenza o trascuratezza nell'uso (es. mancata osservanza delle istruzioni per il funzionamento dell'apparecchio), installazioni o manutenzioni operate da personale non autorizzato, danni da trasporto, ovvero dovute a circostanze che, comunque, non possono farsi risalire a difetti di fabbricazione e/o di conformità del bene. POLIPLAST declina ogni responsabilità per eventuali danni che possono, direttamente o indirettamente, derivare a persone, cose ed animali domestici in conseguenza della mancata osservanza di tutte le prescrizioni indicate nell'apposito libretto istruzioni e concernenti specialmente le avvertenze in tema di installazione uso e manutenzione del bene stesso.

I prodotti dovranno essere installati e/o usati nel rispetto delle loro caratteristiche tecniche e delle istruzioni impartite da POLIPLAST; inoltre dovranno essere installati e/o usati con l'osservanza delle disposizioni di sicurezza e con le disposizioni regolanti l'installazione e/o l'uso del materiale elettrico in vigore nel paese dove i prodotti sono installati e/o usati.

A tal fine la parte acquirente manleva espressamente POLIPLAST SRL da qualsivoglia responsabilità in ordine agli usi impropri, alla mancata osservanza delle norme di sicurezza, delle specifiche tecniche e delle istruzioni per l'uso. I prodotti non rispondenti alle norme e/o alle specifiche tecniche in vigore nell'Unione Europea saranno forniti solo alla parte acquirente che specifichi nell'ordine che il paese di destinazione non appartiene all'Unione Europea e dichiara di aver esperito tutti i controlli sulla compatibilità degli standard di sicurezza presenti nel paese extra U.E. cui sono destinati.

I pagamenti devono essere effettuati secondo le modalità comunicate da POLIPLAST SRL. Il mancato pagamento, anche parziale, delle fatture oltre il termine di scadenza fissato, produrrà l'immediata decadenza degli interessi al tasso di cui al D.lgs. 9 ottobre 2002, n. 231, oltre all'addebito di eventuali spese bancarie e delle commissioni.

Il mancato pagamento a qualsiasi titolo autorizzerà POLIPLAST a sospendere ulteriori invii di materiale.

Ai sensi dell'art. 10 della legge 196/2003 la parte acquirente è informata che i dati personali a lei attinenti vengono inseriti nella banca dati POLIPLAST, essendo ciò necessario per il corretto svolgimento del rapporto contrattuale e per l'adempimento di alcune disposizioni di legge, oltre che per finalità di tipo statistico, commerciale, marketing, promozionali, di tutela del credito, di gestione e cessione del medesimo.

I dati personali della parte acquirente sono trattati attraverso strumenti automatizzati e cartacei da soggetti autorizzati, con l'impiego di misure di sicurezza atte a garantirne la riservatezza. I dati personali della parte acquirente possono essere comunicati ad enti pubblici, a società del gruppo, società di recupero crediti ovvero società, consorzi, o associazioni aventi finalità commerciali, di ricerca di mercato, di marketing.

Il titolare del trattamento è POLIPLAST SRL, cui la parte acquirente può rivolgersi per esercitare i diritti di cui all'articolo 13 della legge sopra citata.

A tal fine la parte acquirente è informata che in qualsiasi momento può avere accesso ai propri dati personali, richiedendone l'aggiornamento, la rettifica ovvero la cancellazione e/o opporsi al loro trattamento.

I diritti e le obbligazioni delle parti sono regolati dalla legge italiana e il Tribunale di Catania ha la competenza non esclusiva in ordine alle controversie che dovessero sorgere in relazione alla vendita dei prodotti.

La parte acquirente irrevocabilmente accetta la competenza del Tribunale di Catania qualora POLIPLAST SRL instauri la controversia presso questo tribunale.

LISTINO PRODOTTI

Poliplast srl - Direzione e Uffici Amministrativi:

Via Oliveto Scammacca, 7/c Tel. +39 095.7357530 pbx www.poliplastsrl.com
95127 Catania (Italy) info@poliplastsrl.com

Poliplast[®]
www.poliplastsrl.com

Gennaio 2023

Ordini clienti: commerciale01@poliplastsrl.com | **Assistenza tecnica:** assistentatecnica@poliplastsrl.com